

Paul Godley on "Choosing Your Regenerative Circuit"

# RADIO BROADCAST

June, 1923

213-2  
The Search for a Telephone as Sensitive as the Ear

Operating a Loud Speaker on One Tube,  
Without Batteries

Radio in Summer Camps

The Best Battery Connections  
for the Set You Use

MA 11  
All Boy Scouts, Attention!

Learning the Code

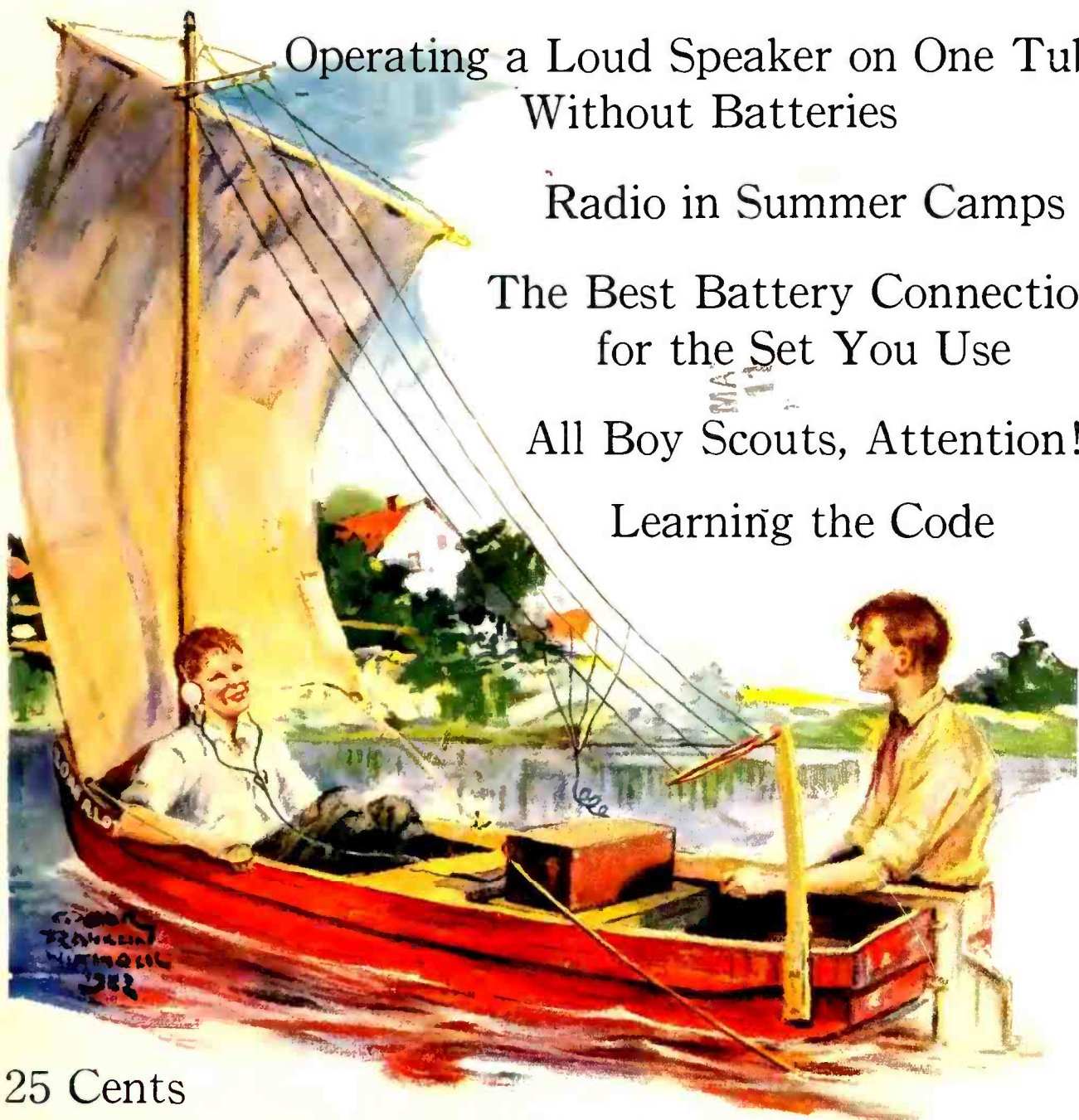

25 Cents



# Cunningham

*the standard tube for all makes of receiving sets*

## Mutual Conductance

### The Correct Rating for Vacuum Tubes

Gas Engines are rated by their horsepower—Electric Generators are rated by their watt or kilowatt output—Mazda Lamps are rated by their candle-power. All of these factors actually express the efficiency of the article for the purpose intended.

In the past vacuum tubes have been known merely as Detectors and Amplifiers. These terms indicated only the use for which the tube was designed, but in no way expressed its efficiency for either of these purposes. Though little known to the general public, there is a factor—MUTUAL CONDUCTANCE—which adequately and accurately expresses the efficiency of vacuum tubes. The new Cunningham C-301-A has the *highest value of mutual conductance ever obtained in a receiving tube*, and it is this factor that is responsible for its *superior operation as an Amplifier*.

Write for Bulletin 1-B explaining the uses and advantages of the term Mutual Conductance as the correct rating for Vacuum Tubes

**Cunningham C-301-A Improved Amplifier Now \$6.50**  
 Filament Current ¼ Amp. Mutual Conductance—600 micromhos at 100 volts plate and 6 volts neg. grid potential

### Patent Notice:

Cunningham tubes are covered by patents dated 11-7-05, 1-15-07, 2-18-08, and others issued and pending. Licensed for amateur, experimental and entertainment use in radio communication. Any other use will be an infringement.

*E. J. Cunningham*  
 Home Office:  
 248 First Street  
 San Francisco, Calif.

For the assistance of the public, in obtaining true musical quality and actual reproduction in broadcast reception, this company will, from time to time, issue Service Bulletins explaining in a clear and simple manner the most important technical features that must be observed in the selection and operation of radio apparatus.

Cunningham Service Bulletin No. 1 explains the use of the factor mutual conductance as the standard rating for vacuum tubes. The information it contains should be thoroughly known to every owner of a radio set who is interested in obtaining maximum efficiency with a given number of vacuum tubes. This bulletin will be mailed to you, free of charge, upon request.



The trade mark GE is the guarantee of these quality tubes. Each tube is built to most rigid specifications.

Eastern Representative:  
 154 West Lake Street  
 Chicago, Illinois



**CROSLEY** "WLW BROADCASTING STATION  
 BETTER COST LESS  
**RADIO**  
 PRODUCTS  
**CROSLEY MFG., CO.**  
 CINCINNATI, O.

**THE HEIGHT OF EFFICIENCY**  
*Crosley Model X, Price, \$55.* ★

Clearly, distinctly, as though given in the same room, messages from WLW Broadcasting Station, Crosley Mfg. Co., Cincinnati, are heard in all parts of America if a Crosley Model X—a four tube radio frequency set—is used. This remarkable instrument, very easy to tune, simple and beautiful in construction, has repeatedly brought in messages over 4900 miles away.

Other Crosley Models, like the Model VIII, three tube set—price \$48, and the Model VI, two tube set—price \$28, have given exceptional results to thousands of satisfied users everywhere.

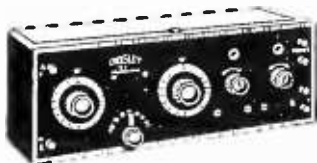

Write For Catalogue Showing Complete Crosley Line.  
 For Sale By Best Dealers Everywhere

Besides a complete assortment of receivers, Crosley manufactures parts for replacement or home construction.

Jobbers and Dealers Will be Interested in the Crosley Proposition.



**New York Office:**  
 C. B. COOPER,  
 1803 Tribune Bldg., 154 Nassau St.

**Boston Office:**  
 B. H. SMITH,  
 929 Blue Hill Ave., Dorchester

**Chicago Office:**  
 R. A. STEMME, Mgr.  
 1311 Steger Bldg., 28 E. Jackson Blvd.

**CROSLEY MANUFACTURING COMPANY**  
 620 ALFRED ST. CINCINNATI, OHIO

**Remarkable  
 Regenerative  
 Receivers**

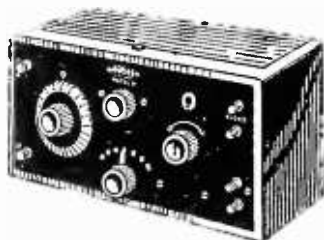

**ACE Model V**  
**\$20** ★

*Formerly known as  
 CROSLEY MODEL VC*

This one tube receiver is astounding the radio world with its wonderful achievements. Stations more than 1000 miles away are being regularly copied on this set. In comparison to its price, there is no receiver on the market to-day to equal it in performance.

Because of its size and price the Ace Model V is a great summer seller.

Licensed under Armstrong U. S. Patent No. 1,113,149.

Live Jobbers and Dealers are eagerly taking advantage of the sales this instrument and the rest of the Precision instruments and parts bring them.

*Free Catalogue on Request*

**THE PRECISION EQUIPMENT CO.**  
*Powel Crosley Jr. President*  
 620 GILBERT AVE. CINCINNATI, OHIO

★ Tested and approved by RADIO BROADCAST ★

# Radio Broadcast

ARTHUR H. LYNCH, EDITOR



## CONTENTS FOR JUNE, 1923

<i>Not a Soul Aboard—Controlled by Radio</i> . . . . .	<i>Frontispiece</i>
THE MARCH OF RADIO. . . . .	91
RADIO IN SUMMER CAMPS . . . . .	ELON JESSUP 102
OPERATING A LOUD SPEAKER ON ONE TUBE WITHOUT BATTERIES	WALTER VAN B. ROBERTS 108
A STORMY P. M. AT ALICE'S . . . . .	WILLARD WILSON 112
Drawings by Thomas E. Monroe	
LEARNING THE CODE . . . . .	WILLIAM HARRIS, JR. 114
IS SHORT-WAVE RELAYING A STEP TOWARD NATIONAL BROADCASTING STATIONS? . . . . .	W. W. RODGERS 119
THE BEST BATTERY CONNECTIONS FOR THE SET YOU USE	EDWARD LINDLEY BOWLES 123
A MAN WHO BUILT A SET HE HAS NEVER SEEN . . . . .	ALFRED M. CADDELL 128
A LOOP RECEIVER IN THE TROPICS . . . . .	CHARLES T. WHITEFIELD 133
WITH THE BROADCASTERS . . . . .	135
PROTECTING YOUR INVENTION . . . . .	ROGER SHERMAN HOAR 136
THE SEARCH FOR A TELEPHONE AS SENSITIVE AS THE EAR	GEORGE B. CROUSE 142
CONCERTS FOR ALL IN A VETERANS' HOSPITAL. . . . .	J. TOWNSEND BRADLEY 147
ADVENTURES ON AN AMERICAN YACHT IN MEXICO . . . . .	A. HENRY 149
Drawings by Thomas E. Monroe	
CHOOSING YOUR REGENERATIVE CIRCUIT . . . . .	PAUL F. GODLEY 154
INTERNATIONAL LAW AND THE SEA-GOING TELEGRAPHER	CLAUDE CATHCART LEVIN 159
SOLDERING YOUR OWN . . . . .	W. S. STANDIFORD 161
THE BROADCAST RECEIVING CONTEST—RULES AND PRIZES . . . . .	164
A BIT ABOUT BOOKS . . . . .	165
ALL BOY SCOUTS, ATTENTION! . . . . .	166
NEW WAVELENGTHS FOR CLASS B STATIONS . . . . .	167
ADDITIONAL BROADCASTING STATIONS IN THE UNITED STATES . . . . .	168
THE GRID—QUESTIONS AND ANSWERS . . . . .	170
NEW EQUIPMENT . . . . .	176

Copyright, 1923, by Doubleday, Page & Co. All rights reserved  
TERMS: \$3.00 a year; single copies 25 cents

F. N. DOUBLEDAY, Pres.  
RUSSELL DOUBLEDAY, Sec'y.

ARTHUR W. PAGE, Vice-Pres.  
S. A. EVERITT, Treas.

NELSON DOUBLEDAY, Vice-Pres.  
JOHN J. HESSIAN, Asst. Treas.

### DOUBLEDAY, PAGE & CO.

THE WORLD'S WORK    COUNTRY LIFE    THE GARDEN MAGAZINE    SHORT STORIES    EDUCATIONAL REVIEW  
CHICAGO: People's Gas Bldg.    GARDEN CITY, N. Y.    NEW YORK: 120 W. 32nd Street  
BOSTON: Tremont Bldg.    LOS ANGELES: Van Nuys Bldg.



# Don't Tear 1923 in Half

How a loop and Acme for amplification make radio a pleasure the whole year round

IS YOUR radio set good for just about six months of the year? Do you want to find a way to get distant stations clearly and distinctly the entire year; to get these stations without the usual amount of interference from government and other spark transmitting stations, from your neighbor's radiating receiving set, or from our old foe "summer static"? Then here's a way.

*Use a loop and Acme for amplification*

Tear down your antenna, put on a loop and use Acme for amplification (preferably with dry battery tubes) and reduce your interference troubles to a minimum. By using Acme for amplification you get more than mere amplification—you get distance and volume without distortion. There's the Acme Radio Frequency Amplifying Transformers (R-1-2-3-4) for distance and the Acme Audio Frequency Amplifying Transformer A-2 for volume, and the Acme Kleerspeaker for clearness. Use Acme in the set you build and look for it in the set you buy. You can buy this standard Acme Apparatus at any radio or electrical store.

A special booklet has just been prepared explaining exactly how to avoid interference and to secure distant stations clearly and distinctly.

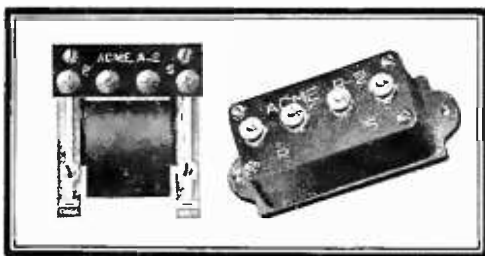

Acme A-2 Audio Frequency and Acme R-2 Radio Frequency Amplifying Transformers. Price \$5 east of Rocky Mountains.

ly. The booklet includes wiring diagrams and other serviceable information. It will be sent postpaid anywhere in the United States, Canada or Mexico on receipt of ten cents or its equivalent in American money. This small charge is made in order to be certain that the booklet is placed in the hands of radio owners and experimenters and that it will not be wasted upon mere curiosity seekers. The coupon is for your convenience.

**ACME APPARATUS COMPANY**

*(Pioneer radio engineers and manufacturers)*

Cambridge Mass., U. S. A.

**SALES OFFICES IN PRINCIPAL CITIES**

New York	Chicago	Cleveland
1270 Broadway	181 W. Washington St.	3707 Euclid Ave.
Kansas City	San Francisco	
208 Baltimore Bldg.	267 Minna St.	

ACME APPARATUS CO.  
Cambridge, Mass., U. S. A.

Gentlemen—Enclosed find 10 cents in (coin), (stamps), for which send me your booklet on wiring diagrams and complete information on Acme Apparatus.

Name.....  
Street.....  
City.....  
State.....

# ACME for amplification

★ Tested and approved by RADIO BROADCAST ★

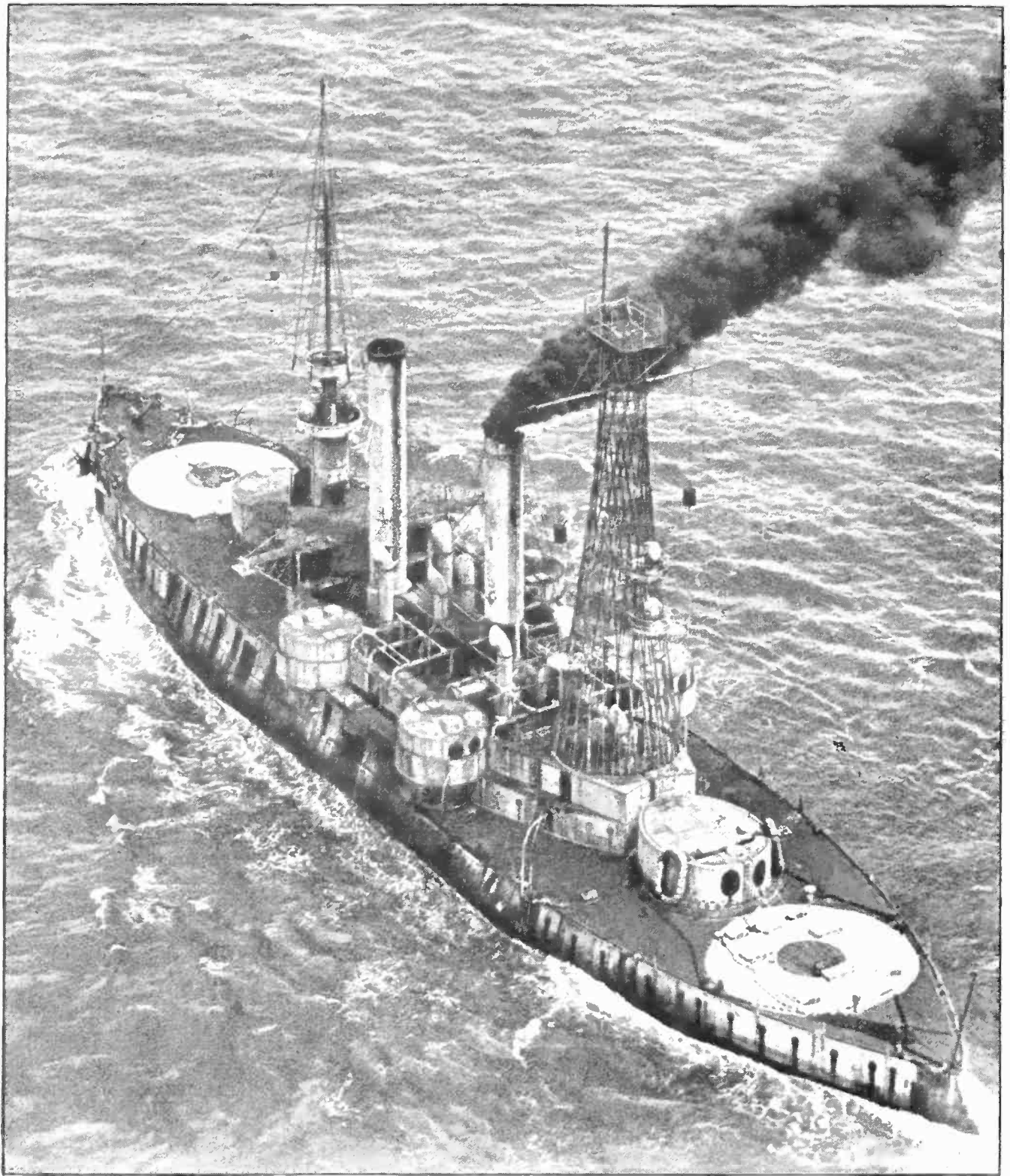

**NOT A SOUL ABOARD—CONTROLLED BY RADIO**

The old U. S. S. *Iowa*, picked as the moving target, in the recent maneuvers off Panama, for the big guns of the super-dreadnought, *Mississippi*. She was guided on her final trip by a delicate system of radio controls. Early in the "battle," this apparatus aboard the *Iowa* was put out of commission, and she was sent to the bottom in quick time, it being no longer possible for her to evade the enemy fire

# RADIO BROADCAST

Vol. 3 No. 2



June, 1923

## The March of Radio

### OUTDOOR EXPERIMENTING IN VACATION-TIME

EVERY man is endowed to a greater or less degree with the spirit of research—the spirit which urges him to investigate, for himself, the region of the unknown. It is probably this desire to know new things, to investigate fields as yet unexplored, more than any other of his characteristics which has differentiated man from the other animals. None of the higher anthropoids has been known to show curiosity about the use of iron ore, for example: to him it remains the same as any other dirt; but to man, who noticed its changes when heated in a fire, it became the source of steel, the basis of our industrial life.

Whereas the research accomplishments of but few men are written upon the pages of progress, it is undoubtedly true that any normal man from childhood up likes to “see what will happen” as a result of conditions he controls. For most of us, however, research must occupy a minor rôle, as the routine accomplishment of the ordinary prosaic tasks must necessarily use most of our time and energy. To him who is more than ordinarily gifted with the spirit of investigation the life of the real research worker—who year after year as his sole occupation pursues the unknown—must seem like one long journey through Elysian fields.

The office or factory tasks seem very unattractive when compared to this work carried out in the spirit of “I must find out.” Although the large industrial companies are very

rapidly expanding their research staffs and laboratories, there can never be more than a very small percentage of us actually engaged in research work as a profession. The labor of the researcher must be supported by the more matter-of-fact jobs of the factory and office worker. Most of the research men’s labors bring forth nothing new of material value, so that it is a foregone conclusion that most of us must be content to perform our routine tasks efficiently to support the researcher, and we must satisfy our investigating spirit by imaginative trips or by reading of the work accomplished by others.

The general interest in radio has brought thousands of us closer to a new and unexplored field than we had thought possible, and in this field we can labor to our heart’s content, for the cost of the apparatus is generally within our means and the corner of the living room suffices for a laboratory. That radio does serve as an outlet for the “I’d like to know” spirit of thousands can be judged by the conversation of young and old as they compare notes on their way to and from work. Hundreds of thousands of people to-day are wondering *why* something happens who would not have had their imaginations excited had it not been for radio. Each night sees a new connection tried, new types of apparatus substituted for old, and subsequent comparison of notes with a pal who has been trying something else.

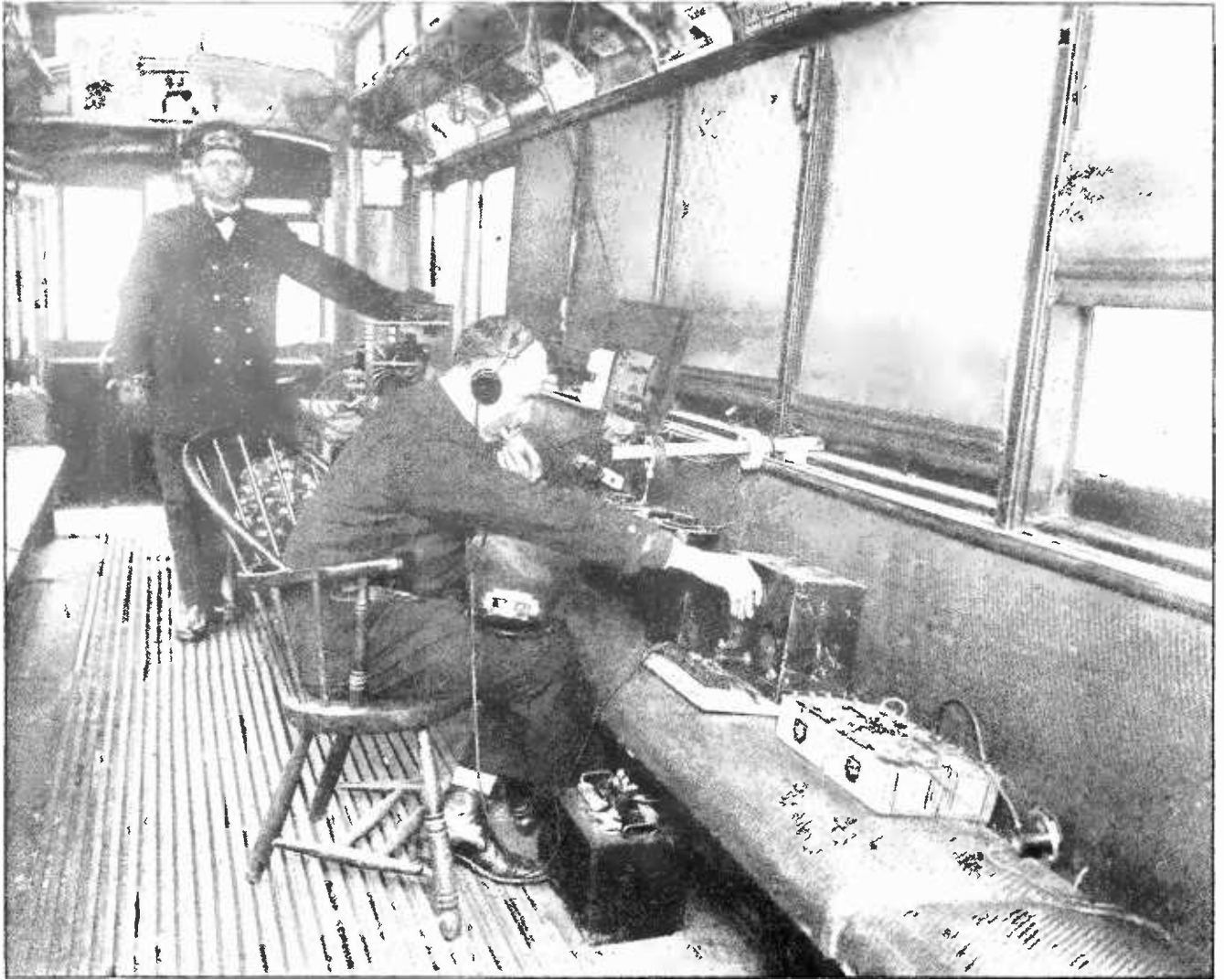

#### EXPERIMENTING WITH RADIO TELEPHONY IN A NEW YORK TROLLEY CAR

The Third Avenue Railway Company, in conjunction with the General Electric Company, has completed a series of experiments wherein radio carrier currents are used on the feeders and trolley wires of its overhead system as a means of communication between points on the system. The transmitters and receivers are similar in many respects to the general run of broadcasting outfits and satisfactory communication has been established between substations and dispatchers' offices and the trolleys. Since the receiving point may be at any point of the line, emergency calls will reach their destination in record time and the exact nature of the apparatus needed to remedy whatever troubles may develop will be transmitted. In this way, operating delays will be reduced to a minimum. Conductor George Dwyer is shown trying out the new apparatus

All the good things in radio haven't yet been discovered. To be sure, regeneration and heterodyne reception cannot be re-discovered and their rich rewards again be obtained, but who knows what still more interesting and valuable ideas are hidden, awaiting some investigator's disclosure? According to the theory of probability, perhaps not more than one in a hundred thousand listeners will discover something which is commercially worth much, but the fun and exhilaration of testing and experimenting is open to all, and this kind of work is in itself sufficient reward.

It is not ordinarily possible to carry out tests on our antennas, as the local conditions generally fix their installation, but with the coming of

summer and vacations and auto tours, a fascinating field of work is opened for the radio enthusiast. How does a signal decrease in intensity as the distance from the transmitting station increases? Does it decrease as rapidly if we stay near a large river as if we move over country away from it? How far will a crystal set receive? Does ground resistance really have much to do with the strength of a signal? Let's try it by grounding our antenna right in the stream by which we are camped and by laying a counterpoise wire on the dry ground, or by using the automobile frame as ground, this being well insulated from ground by the tires. Is a single wire antenna actually as directional as "everybody says?" It will be easy to find



out by stringing the antenna to different trees in different directions with respect to the transmitting station. Is the radio compass a reliable way of locating a radio station, or does the presence of streams, ocean shore, etc. greatly affect its accuracy? Using loop antenna, maps, and a magnetic compass, the tourist may answer the question for himself. Is there really a detrimental effect caused by trees around the receiving antenna? It's perfectly simple to find out by trying.

While the answer to these questions, even if reliably obtained, will not materially enrich the experimenter, the "finding out" will prove interesting and fascinating to the average man and the work (or play) involved in determining the answer will be well worth while. So let radio increase the pleasure and profit derived from this summer's trips—take the radio set along with you so that you can experiment when the urge is upon you, and when the set is not being used for experimenting it will keep you in touch with your favorite stations

and make the evenings more pleasurable to you and to the others who will be sure to visit the tourist who has his radio along.

### Hoodwinking the Listeners-In

IT was not long ago that we called to the attention of those who make up the programs of the broadcasting stations their responsibility to the radio public for the material sent out. Programs are generally made up some weeks in advance so that the excuse of "no time" cannot be offered in extenuation. Managers must assume the same responsibility for the quality of the material sent out from their



© Underwood & Underwood

SIR BASIL THOMSON BROADCASTING HIS FAREWELL TO AMERICA  
The former Director of the Special Branch (detective division) of Scotland Yard giving from WJZ's Waldorf Astoria studio, in New York, his last talk before sailing for the Bahamas

station as the average commercial house does for the goods purchased through it. If the material to be broadcasted lies outside the realm of knowledge of the manager, he should call to his assistance some acknowledged authority who can vouch for the reliability of the lecture. But it would seem that for talks on radio matters the manager himself should assume the responsibility. We wonder why an attempt to hoodwink the listening public as to the possibilities of the crystal receiver was recently permitted. "Operating a loud speaker from a crystal set"—any manager who thinks that possible should give up his job and take one speculating in oil or some other field where his



#### TRANSMITTING RADIO MESSAGES WITH THE TELETYPE MACHINE

Chief Gunner J. J. Delaney, at the naval radio station, Washington, has only to press the keys as if using an ordinary typewriter: the letters, automatically "put on the air" as radio code symbols, are instantaneously decoded again at the receiving station by a machine which also prints them, "in English," exactly as they are sent

imagination will have sufficient play. A crystal set alone could not possibly operate a loud speaker, unless the listener was perhaps within a stone's throw of the transmitting station and even then the signal would be very poor. How then did this promotor propose to operate a loud speaker from a crystal set? By acceding to his request to write for particulars we found that it was necessary to have an ordinary audio-frequency amplifier, of the vacuum-tube type, to help the crystal!

Why the speaker was allowed to speak on this misleading topic we should like to know. Had he said that his method involved the use of ordinary triode amplifiers he would never have received the number of letters he did. The pile of letters, "more than received by any previous speaker at the station," as was announced, represented just so many radio listeners who, trusting to the judgment of the station manager, had been hoodwinked and have lost much of their faith in the accuracy of the material sent out from this station. A little of such misleading advertising goes a long

way towards spoiling the reputation of the man who so questionably advertises his goods by radio. Instead of bringing sales, such broadcast talks will eventually ruin completely the advertiser's estimate of the value of radio. Discreet advertising, which merely announces that the A. B. Company of C and D streets is offering the program for the next hour and would be pleased to receive suggestions from the radio audience as to future programs, will probably pay in the long run even though its immediate value may not be apparent; but advertising which insults the intelligence of the listener, as that on crystal sets and loud speakers, leaves a bad impression—involving not only the speaker but also the station.

#### A Big Demand for Educational Radio?

**W**ILL radio serve as an adjunct to ordinary methods of college instruction? Will the instruction given in the class room be supplemented to an appreciable degree by broadcasted lectures?

There has been much talk lately by the National Radio Chamber of Commerce about helping the colleges to establish a radio broadcasting service; besides the question as to just what the Chamber can do to help in the work, the very important question must first be answered: Is there a real demand from the radio public for educational lectures of the kind given in college class rooms?

There is undoubtedly a demand for educational material in radio broadcasting, but the demand is for the indirectly educational subjects—the kind of material one gets in listening to good musical numbers, or opera. One cannot help receiving education and inspiration from good music well rendered and there is an increasing demand for it. The managers of the broadcasting stations agree that a great percentage of their audiences prefer operatic selections to jazz. On the other hand these same managers are unanimous in their opinion that lectures of the kind and quality given in class room will not hold the radio audience.

In the class room, the gesture and personality of the instructor, and blackboard illustration, as well as the student's interest in the subject matter, serve to hold his attention. But no such advantages rest with the radio lecturer; his first phrase must capture the interest and curiosity of the listener and every sentence must be so meaty and to the point, with prediction of more interesting things to come, that there is no inclination to re-tune to a competing musical program. Neither politeness nor a desire to "stand in" with the instructor can command the interest of the radio listener—the subject matter alone must be presented in such an attractive fashion that it is considered worth while.



A SERMON'S A SERMON FOR ALL THAT

A glance at the quality of the pictures offered to the movie public indicates that if a demand for educational films has been made, the producers have estimated it to be of almost negligible importance. Occasionally a film with a certain amount of educational material incorporated does appear, but the meagre success of such attempts to educate the masses is evidenced by the scarcity of pictures of this kind. If there were two movie houses of equal accessibility and price, one showing some important industrial process or historical development and the other putting on the latest and hottest from Hollywood, there is no doubt whatever which house would echo with emptiness and which would need stampede regulation at its portals.

Now it may well be questioned whether the



#### NO HANDLE TO TURN ON THIS HURDY-GURDY

This outfit recently made its appearance on the streets of London, where all and sundry were regaled with radio melodies. Within the box is a 4-tube receiver, and two loud speakers facing in opposite directions. It is said that everyone from a newsboy to an M. P. can be stopped in his tracks at 200 yards' range when this apparatus opens up

analogy of the movies is justifiable, on the ground that the average movie audience is, in general, less particular about the quality of its entertainment than the radio audience, that the educational material which would fall flat when offered to one class would be eagerly awaited by the other. This is an hypothesis which cannot be answered at this time; but we rather question its accuracy. The only method of getting accurate information on such topics is by analyzing the correspondence received by the managers of the broadcasting stations, and it is evidently impossible to use this source of information until the experiment has been thoroughly tried out. It may well be that we shall find a sufficiently wide-spread interest in some branches of education to make it worth while, although for other branches there is no appreciable demand.

In this connection we note with interest that morning broadcasting between 11:00 A. M. and noon has met with unexpected success.

Feeling that many women would appreciate lectures of an informative nature, The Town Hall, a New York organization devoted to promoting worth while things, especially in music and literature, has started to send out through WEAJ their morning lectures. From the letters received those responsible for the experiment feel well pleased. One appreciative listener writes: "I feel that it is a wonderful privilege for a busy house mother to pause for an hour and be completely 'transported' to other lands and scenes. When our tired families are home at night the radio is theirs for refreshment, but the morning is mother's own, and I for one sincerely hope that the lectures will be continued."

So do we. Here is apparently a real service for radio to perform, and we hope sufficient stations will take up the idea. It cannot be expected that the mothers will be able to get reception over thousands of miles as their young sons sometimes do in the night time when

conditions are favorable; it will be necessary for many stations well distributed, to undertake this service before it can be widely appreciated.

But this, however, is quite possible. The large department stores, which most need to convince the mother of their value and desire to serve, are just the places where the broadcast stations are quite generally installed. What better way of advertising to a picked clientele? We suggest that the experiment started by the Town Hall management be taken up all over the country; the increase in cost due to running the station an hour in the morning is not great and the return might possibly be greater than it is from the more expensive evening program. It seems that not only general lectures on art and literature are suitable for such a morning program, but the courses in home economics and similar subjects which are offered in the better colleges should prove attractive to the home keepers of the country.



### The Accurate Measurement of Signals

LAST month we referred to the theory that radio waves do not travel in all directions with equal ease. After comparing statistics gathered from listeners located in various directions around a transmitting station, we have been forced to the conclusion that such is actually the case. Since we commented on this matter there has appeared a paper on the accurate measurements of radio signals, a paper prepared by three of the research engineers of the Western Electric Company. This company has had opportunities to sell hundreds of transmitting stations, but has consistently "lost" these sales when it has seemed that the intended installation was not a wise one, either from the standpoint of the purchaser or the radio public. In following out this policy the engineers have seen that it would be very necessary for them to know not only the general conditions under which the station was to be used, the wavelength, probable interference, etc., but the effect of the *location* of the station. This point had been brought home to them very forcibly by the comparatively poor performance of their own station, WBAY. Before the preliminary tests on this station

were carried out it seemed that the performance must be excellent, but actually it was disappointing. At the desired wavelength, 400 meters, the antenna system radiated poorly; at a very much longer wavelength, about 800 meters, it performed very well, the signals in the field were much louder than could possibly have been predicted.

The peculiar behavior of this antenna at once convinced the research men and designers that they must have accurate data, not guesses, on the power radiated from the antenna. How much better was the signal at 800 meters than at 400 meters? How did it vary in strength as the wavelength was varied between these limits? After a year or more of work, a measuring machine had been designed, built, and tested, which proved satisfactory. It was mounted on a truck and taken out into the field for making signal measurements on

the defective station. These tests showed conclusively that the radiated power at 800 meters was about 100 times as great as at 400 meters, whereas ordinary theory predicts it should be only one quarter as much. Theory and practice differed by a factor of 400. It was found that the station, located on the top of a sky-scraper, was using as its antenna, not the wire system which had been strung on the steel poles erected on the roof of the building, but the whole building.

Having used the measuring apparatus for the solution of this special problem it was next put to the task of measuring signal strengths at various points around transmitting stations. The apparatus, being self-contained and mounted in a small truck, could be quickly carried to any point at which it was desired to measure the signal strength. So far, it has worked only in the neighborhood of New York, but even in this limited territory it has achieved remarkable results. By making measurements at various points, in all available directions, the points all being approximately twenty-five miles from the New York station doing the transmitting, it was found that northeast of the station the electric field of the signal was only one tenth as strong as it was in a northwest direction. This means that the signal received northeast of the station would be only one hundredth as strong at an equally distant point in a westerly direction, thus confirming



#### WINNER OF THE HOOVER CUP FOR THE BEST AMATEUR STATION

The Hoover cup, awarded annually to the owner of America's best amateur radio station, has been presented to Frederick R. Ostman of Ridgewood, N. J., operator of station 20M. This trophy is the highest honor in amateur radio and is awarded by the Department of Commerce through Secretary Hoover to the best all-around amateur station, the major part of which is home-made. Mr. Frank Frimmerman's station, 2FZ, located in the Bronx, New York, was judged the second best amateur station. 2FZ was described and illustrated in RADIO BROADCAST for April.

the decision reached by statistically comparing notes of various receiving stations at different points.

Not only in showing conclusively the trouble in existing stations but in making it possible to find a good location for a new station, this apparatus has already justified the time and expense required to develop it. By putting up a temporary antenna on the building where it was anticipated the new station was to be erected and making signal measurements in the surrounding territory it was shown that very poor results would be obtained. Not only did the results show that the building was too high to be suitable for a 400-meter station but the location of the building among neighboring sky-scrapers was such that in the direction where most of the prospective listeners were located the transmission was particularly

poor. Other temporary antennas were erected on other buildings available for the station, and the field measurements showed decisively the superiority of one of the buildings over the others.

The value of these measurements will be apparent when it is mentioned that one of these stations costs about \$25,000 to install; as these preliminary field measurements have shown the chosen site to be about five times as good as the one which would have been chosen had the measurements not been made, it is evident that they increased the effectiveness of that \$25,000 investment in the ratio of five to one. The work of the three engineers responsible for the development of this measuring apparatus—Bown, Englund, and Friis—has been well done, and they deserve the hearty thanks and congratulations of all listeners-in.

### Help the Boy Scout with His Radio

**T**HERE is probably no doubt in any one's mind regarding the value of the Boy Scout movement. If there is, let the doubter meet one of the troops on the hike and get in conversation with the members or listen to what their Scoutmaster has to say. These healthy, wide-awake boys will soon be the leaders and backbone of the country. The development in them of the right way of living and thinking is the most worth-while work in which any one could engage. These boys' love of the outdoors will undoubtedly make them more suitable for framing and maintaining laws regulating our natural resources, a problem which will have assumed tremendous importance by the time they grow up. The spirit of fair play, with which every Scoutmaster seeks to imbue his followers, and which Scouts so generally show, is an attribute

which will go a long way toward solving the difficult economical problems of continually growing importance. From whatever angle it is viewed, the Scout movement shows up so well that no intelligent man could reasonably withhold his support.

A Scout activity which will serve the double purpose of assisting the Scoutmaster in laying out interesting tasks for his followers and of directing the boys into accurate and interesting experimental work has to do with radio. Every troop on the hike this summer should have along with it a radio outfit for listening to the distant transmitting stations. Receiving sets using dry-cell tubes are not difficult to transport, and in the hands of a skillful operator will receive hundreds of miles.

To see how quickly an antenna could be strung to a neighboring tree and the set be put into operating condition should prove an interesting addition to the Scouts' varied activi-



#### AN APARTMENT HOUSE STATION THAT SUPPLIES BROADCASTS TO 72 TENANTS

The landlord of a Newark, N. J., apartment house has installed a receiver in his building, which gets broadcast programs from all over the East and Middle West. Each family or tenant is a subscriber, having only to plug in phones or a loud-speaker on the line terminating in his own living-room, to receive the concerts that Operator James Walsh tunes in

ties. In case two or more sets are available, contests to see who can first get "in touch" with the outside world would be welcomed by the troop. Our purpose in writing this is not so much to interest the Scouts in radio—they are interested in it already—but to let their dads know that a request for financial assistance toward a radio outfit may offer them a mighty good investment.

### Commercial Broadcasting in Germany

**I**N SPITE of the troubled condition still existing in Germany, radio is apparently slowly progressing along the paths it has already followed in this country. Germany has, in the past, been in the forefront of radio development; her engineers and artisans have turned out some wonderful radio equipment. The Goldschmidt alternator is a marvel from the standpoints of both design and construction, and the Telefunken marine sets were probably as efficient as any ever put into ship service.

Had the war not occurred, broadcasting by radio telephone would probably have progressed technically in Germany as far as it has here, and certainly it would have been better controlled and regulated by the Government. It is difficult to imagine how government action, anywhere, could have resulted in a condition worse than that at present existing here. A private company (Eildienst Gesellschaft) has started the commercial exploitation of radio broadcasting by renting receiving equipment to subscribers, who pay 500,000 marks annually for the service and use of the sets. The present subscribers are mostly banks and business houses, and the news broadcasted twice daily contains principally financial notes from foreign lands. An agency in New York transmits stock quotations, and other commercial matters to the high-power station at Nauen, near Berlin. The material is then broadcasted over Germany from a government station which this private company leases for the required time. It is anticipated that the material despatched by the American agents will be received by the broadcast licensees within ten minutes of the time it is sent from New York.

We wonder just what the company anticipates doing to the firms who 'make their own' and so are able to receive the broadcast service without paying the subscriber's fee.

### A New Station for Sweden

**A**N ANNOUNCEMENT from the Department of Commerce gives the particulars about the new station to be erected by the Swedish Government at Goteburg, the port at which cables enter Sweden. The contract, which was obtained by an American company in competition with British, French, and German bidders, will furnish for the station a 200-KW Alexanderson alternator. The steel antenna towers will be similar to those of the radio Corporation station at Rocky Point, with which station the Swedish station is expected to communicate directly. Most of the apparatus will be built in America, but the towers will be designed and built in Sweden.



It is expected that the station will be completed before the end of the year, and that a large transoceanic traffic will be built up with this new connection. At present, Sweden has to rely on other countries for making its foreign connections and too frequently this has proved commercially disadvantageous.

One special service which it is anticipated will be inaugurated through this new station is free medical advice to ships at sea, the advice to come from the best hospital staffs in Sweden.

As Sweden is essentially a maritime nation with thousands of seamen on the fishing banks within radio reach of their home ports, this service will probably prove of such worth as to strengthen further the Government's determination to maintain her communication system well abreast of modern developments, a work in which the Government has been actively engaged during the last three years.

### Increased Speed of Radio Traffic

**S**EVERAL times there has been announced through the press the accomplishment of high-speed radio communication, but in general these spectacular results have been maintained for a short time only, when the conditions were especially favorable. A recent communication from the Radio Corporation shows that the development of the automatic transmitter and high-speed receiver required for communication at rates in excess of thirty words a minute is steadily progressing.

The report states: "On the last voyage of the





#### U. S. FOREST SERVICE BOATS IN ALASKAN WATERS

The *Wanigan*, floating home of the men who patrol the Tongass National Forest, keeps in communication by radio with its motor boats. The latter serve as tenders, towing the houseboat from place to place along the shore line, bringing supplies and performing various duties necessary to the protection of the territory. The *Tamm*, shown at the left, is the headquarters boat, which has survived many storms and by the use of radio has helped to save both life and property

White Star liner *Majestic*, the world's greatest steamship, radio messages were exchanged with shore stations of the Radio Corporation of America at speeds of more than eighty words a minute when the vessel was one thousand miles at sea. Ordinarily, speeds in excess of about twenty-five words a minute cannot be attained by hand sending, and in order to meet the demands of increasing radiogram traffic created by the large passenger liners, machine sending must be used, in which case a given message can be sent and received in one third the time required by manual methods.

"The earlier experiments aboard the *Majestic* permitted only one-way high-speed transmission, namely from ship to shore, there being

no apparatus on board the vessel capable of receiving high-speed transmission. In order to effect two-way high-speed telegraphic service on the vessel during the last voyage to New York it was equipped by the Marconi Company with a high-speed receiver which worked most satisfactorily. High-speed signals were also received from Paris at a distance of eight hundred miles at eighty words per minute. Wireless press was completely and perfectly recorded by the automatic receiver through medium static. The principal benefits will be derived from the new apparatus when it is installed on all vessels of the larger type which handle great volumes of traffic."

J. H. M.

# Radio in Summer Camps

By ELON JESSUP

Whether you are a father, mother, or young son or daughter, you will enjoy this interesting article about the increasing use of radio in boys' and girls' camps.

Possibly you have heard of Lloyd Espenshied, the radio engineer who was instrumental in bringing about the first communication by radio telephony between Washington and Paris, and Washington and Honolulu; or you may have operated one of the receivers designed by H. R. Langley of the General Electric Company; but it is unlikely that you know that both these men first became interested in radio at a certain summer camp up on Lake Champlain.

If camp life holds any appeal for you, you should not fail to read Mr. Jessup's description of what radio is doing for young Americans out-of-doors.—THE EDITOR.

**L**AST summer, more than 500,000 American boys and girls, ranging in age from six to eighteen, were members of summer camps. Considering that a few years ago, within the memory of all of us, the institution of summer camps for

young people was almost unknown, this is a pretty fair indication of how firmly the idea has taken hold.

The exceptional educational and recreational opportunities for young America which these camps represent is too well known to require

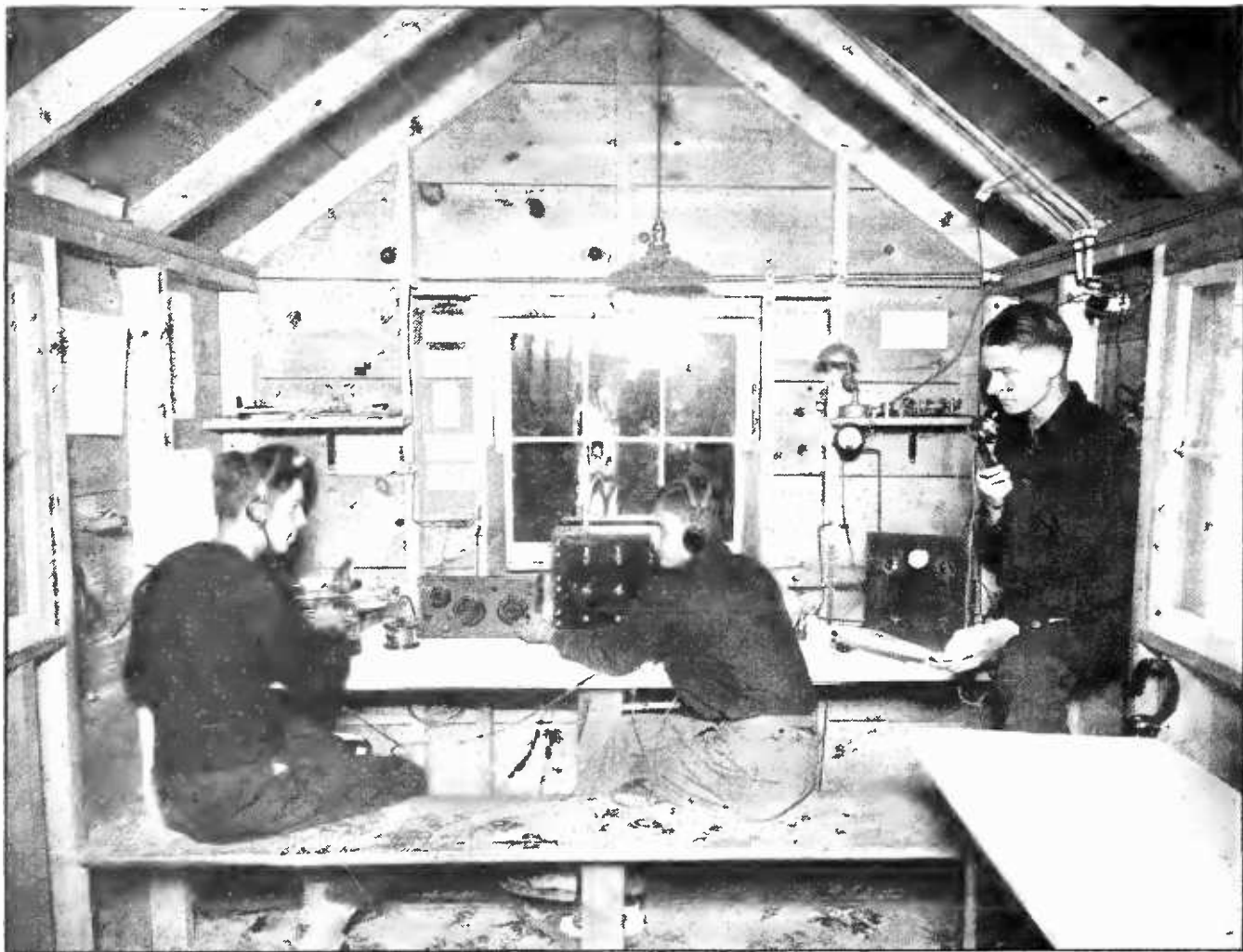

IN THE "SHACK" AT CAMP DUDLEY

This camp has been using radio since 1908! Every summer, a club, consisting of enthusiastic experimenters, operators, and others interested in radio, holds weekly meetings and engages in all such activities as regular transmission and reception, construction of apparatus, and code and theory classes



CALIFORNIA SCOUTS WITH THEIR 3-TUBE RECEIVER AND SPARK-COIL TRANSMITTER

Bulky apparatus can be carried to the camping place by auto or trek cart, but an evident improvement for a portable station would be the use of dry-cell tubes, making the heavy storage battery unnecessary. These Scouts use a strip of wire mesh, which they place in the water or bury in damp earth, for their ground connection

much comment. As one camp director has expressed it, you find in the well-run camp "healthful recreation, wholesome companionship and educational advantages combined in a program of activities that is in keeping with the progressive tendencies of the day."

To the person interested keenly in radio, the phrase "progressive tendencies of the day" may perhaps give rise to curiosity as to just what is being done with radio in these numerous camps. For here, unquestionably, is an activity having at once recreational and educational value. Logically, it would seem to have a very real place in the average camp program.

The answer in a general way is as follows: in Boy Scout camps, the use of radio and the interest in it are practically universal, and have been for some time; a Boy Scout troop not having a radio outfit is a rare exception. Furthermore, this may be applicable even to winter camps, as indicated by six hundred Boy Scouts who last winter spent their holidays camping in the Interstate Park of New York and New Jersey. Radio sets were almost as thick as snowshoes and skis.

As for the camps which are not connected

with the Boy Scout movement—"private camps" as they are commonly called—it may be stated, broadly, that two summers ago there was no interest in radio to speak of, last summer there was a smattering of interest and during the coming season there promises to be a great deal of interest.

Last summer I visited several of these camps, some of which were for boys, others for girls, and more recently I have talked with numerous camp directors whose camps I had not seen. I wanted to know whether radio was included in their programs of camp activities, and if not I was curious to learn the reasons for its absence. Various attitudes which I met were about as follows:

Some directors showed an entire lack of knowledge and interest in radio and expressed distaste at the suggestion of its being used in their camps. Other directors expressed interest in radio and wanted to know more about it. A few directors freely acknowledged that radio had proved a valuable addition to their camp activities.

As regards the first of these three attitudes: there are some camp directors who frankly object to having a radio set on their premises.

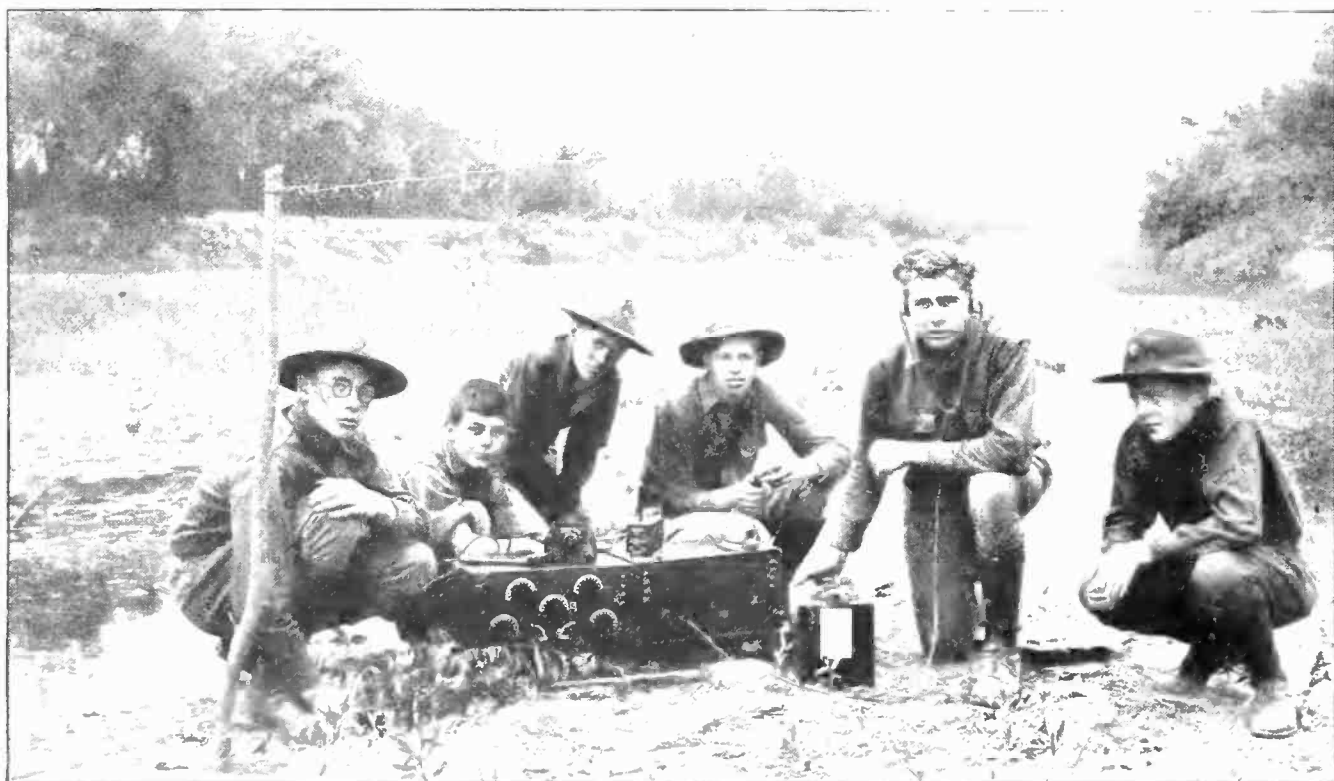

THE SET IN OPERATION

A good aerial can be strung up almost anywhere, in the country, and even a very small portable transmitter will send out its signals with a practical range of a mile or so. The single-tube transmitter is undoubtedly what Scouts and campers are going to use more and more. With careful planning, all apparatus for both transmitting and receiving, except the batteries, might be placed within a box the size of either of the receiving cabinets shown in the picture.

Their reason for feeling this way about it is that they wish completely to divorce camp life from any suggestion of city life. A radio set they classify more or less with automobiles and the movies; something of a distracting influence. During the two or three months while the boys or girls are in camp, these directors feel that they should be living in as complete isolation as possible from the outside world.

I report this attitude, without comment, as I found it. Those who hold it, are, I believe in the minority.

The majority of camp directors are in the second classification which I have given; theirs is the "we'd like to know about it" stage. And this stage in turn is perhaps evenly divided between those who have not had any radio sets in their camps so far but contemplate putting them in, and, on the other hand, those who have experimented slightly with radio and would like to go further with it.

Many camps have "played" with the idea of radio but with the exception of the Boy Scout camps, there are very few so far that have gone at the subject in a really business-like way. As I have indicated, however, there is a growing

interest in radio both from the standpoint of education and entertainment.

As regards girls' camps, radio is regarded almost exclusively as a means of entertainment, for girls are not generally considered to have a mechanical turn of mind; yet, as indicative of the fact that this commonly accepted theory does not always hold true, I might mention that some time ago the Young Women's Christian Association gave a course in radio construction. During the coming season, the Y. W. C. A. intends to install several radio sets in its summer camps.

Boys, of course, are more technically minded than are girls. And almost all boys like to hear the baseball scores and listen to an occasional concert. The wise camp director realizes full well that when a boy is genuinely interested in a given subject, he should by all means be given every facility for expressing this interest.

That is one reason why directors, of boys' camps especially, are turning more and more to radio. The boys themselves have to some extent created the demand. A boy brings to camp a set that he has made at home and a goodly proportion of the rest of the crowd immediately wants to make a set like it. Con-

sequently, in a number of camps, the construction of radio sets has become a recognized camp activity.

For example, I have in mind one camp in which boys last summer spent one hour each day on the construction of crystal sets, each of which, after the camp was over, was carried proudly home. Only a comparatively small proportion of the boys were engaged in this activity.

Yet, as I have indicated, camp directors as a whole are in something of a quandary about radio both as regards entertainment and instruction. It is a new subject to them and they are not yet "sold" on radio. No doubt there are several exceptions to this rule and I will tell you about the one notable exception with which I am familiar. I am now speaking of a boys' camp which is in no way related to the Boy Scout movement—Camp Dudley on Lake Champlain, a camp of about two hundred boys ranging in age from twelve to sixteen.

Two significant facts are attached to this camp, one of these being that it is the oldest organized boys' camp in America and the other is that wireless work has been one of its activities for more than fifteen years. Thus,

one has here an exceptional opportunity to view methods and results.

First, as regards tangible results. The boys who in the past spent their summers at Camp Dudley have grown up and gone out into the world. Some of these boys when in camp had no idea about the sort of work they intended to go into; others did. Take for example, R. H. Langley, now in charge of the receiving section of the radio engineering department of the General Electric Company. His first interest in wireless was aroused when he was a boy in Dudley. The same is true of Lloyd Espenschied, the engineer who was instrumental in bringing about the first wireless communication between the Pacific Coast and the Philippine Islands.

Radio, in its present-day phase, so far as Camp Dudley is concerned, dates back three years. Then it was that a club was formed among the boys, who forthwith became gleeful over obtaining permission from their "Chief," H. C. Beckman, to build a "shack" in which to house the instruments and serve as a clubhouse. Carpentry is one of the camp activities, so they knew how to build a real house and they made a good job of it.



LOCAL RECEPTION ON A LARGE LOOP ANTENNA

First Class Scout Malmros of Troop 1, Roslyn, Long Island, tuning in signals from his headquarters radio telegraph station



THE WIRELESS TOWERS AND RECREATION BUILDING AT CAMP WALLKILL, NEAR LAKE MOHAWK, N. Y.

Membership in this club became in the boys' eyes a desirable goal. Not every boy was permitted to join it. You had, first of all, to know quite a bit about the principles of wireless. Two years ago the membership was somewhat limited but last year about half the boys in camp belonged to the club.

There are, no doubt, many people who would like to know how this radio club functions. The following details were related to me by Martin Walter, Jr., who has been actively engaged in wireless work at Dudley for a number of years, first as a boy in camp and later as an assistant to the director. It is commonly the custom at Dudley for many of the boys to come back to camp season after season, and then when they reach college age some of them become assistants to the director. Mr. Walter says:

"Our radio club at camp is governed by what we call the 'radio committee'. This consists of about six of us who have been interested in wireless work for several years. We all have government licenses and consequently know the code well enough to receive press dispatches every evening. Last summer, however, this was not necessary, as the broadcasting stations

furnished most of the matter we were interested in. This was mainly baseball scores, the weather for our section, correct time, and even stock reports which some of the older fellows were interested in. As soon as the news was received it was neatly typed and posted on the 'radio bulletin' which occupied a prominent place on the wall of our dining hall. Music was also received every evening and this brought quite a crowd of listeners to the 'shack.'

"We had a small transmitting set and under favorable conditions we could talk with fellows in New York City. However, we had a regular daylight schedule arranged with an amateur in Albany (about 150 miles) and another with the University of Vermont, Burlington (about 50 miles). By relaying to these stations, messages were sent home by the fellows. One of the committee was supposed to be in the shack all the time, and he was responsible for the apparatus. Any one could come in and work the receiving set, provided the consent of the man in charge was obtained, but only fellows holding transmitting licenses were permitted to use the sending set.

"The men on the committee were not

allowed to serve as officers of the club but assumed a position something similar to a board of directors. Elections were held by ballot for the officers. We had no dues, as the camp supplied everything. The regular meetings of the club were held on Sunday afternoons. All boys in camp were welcome to attend and a good many became interested in this way.

"After the roll call, one of the committee generally gave a talk on constructing sets—how they worked—and simple theory. We were lucky last summer in having at camp a Navy operator and he gave talks on his experiences which were always very interesting and well received. Occasionally, a visitor came up who had had some experiences and he was never allowed to get away without giving a talk.

"After the meeting was over, the committee was always on hand to answer any questions, and you may be sure there were enough to keep

us busy. We also had code classes twice a week. These did not work out quite so well, probably because the fellows were too young to be interested in that end of it. After a whole summer of practising, a few fellows got enough speed to take the license exam. when they got back, and the rest of them knew, at least, that there was a code.

"For the first time, last year, we started making sets. This took very well and several sets were finished at camp and a number more were in the 'all but' stage. This idea was started late in the season, or more would have been constructed. We drew up plans for a standard set costing about twenty dollars and any one wanting to make it had to have his parents' consent. After determining the number, a bulk order was sent to a firm in New York and in this way a discount was obtained. After the parts arrived the sets were made in the shop and tried out in connection with the regular camp set."

#### 72% OF THE 1922 CAMP WALLKILL BOYS CONSTRUCTED SETS

The radio workshop where boys are given instruction in building their own apparatus. Five of last summer's campers passed the government requirements and obtained operating licenses, through the training they received at camp



# Operating a Loud Speaker on One Tube, Without Batteries

By WALTER VAN B. ROBERTS

Princeton University

THOSE who are fortunate enough (from the present point of view) to have 110 volts *direct current* available at every lamp socket will find the receiver described below to have the

following advantages:

1. It uses no batteries of any kind, thus eliminating all battery cost and upkeep.

2. It makes use of a loop aerial, which saves the trouble of stringing an aerial and allows the receiver to be set up at any place in the house where a lamp socket is handy.

3. The output is great enough so that local stations (say up to 25 miles) can be heard satisfactorily over a good-sized room.

4. In operating, only two adjustments are really necessary, and neither of these is difficult to make.

5. The cost of the parts is small, compared to the cost of parts that would be required to get the same volume out of the loud speaker by any other means using a loop aerial.

6. Only one vacuum tube is required.

There are disadvantages also:

1. The set cannot be relied upon for satisfactory loud-speaker results from distant stations, although on some nights distant stations can be heard surprisingly well.

2. The quality is not so good as that obtainable by other means. There is the very high weak whistle of the interruption frequency of the super-regenerative circuit, and if the signal is very weak a certain amount of hissing noise develops in the circuit itself. However,

if the signal is fairly strong, the quality is good enough for all practical purposes.

3. It is not very selective. This is one reason why distant stations are hard to get. However, there is no difficulty in separating the 360-

from the 400-meter stations, even if the one to be excluded is only a few miles away.

On the whole, it is probably the most practical arrangement at present available for those who want loud-speaker results with no upkeep cost or bother with battery charging, who are satisfied with the programs of local stations, and who have the necessary direct current supply.

On page 110 is shown the circuit, which is seen to be the one made public by Arm-

strong except for the rearrangements which are necessary in order to avoid using batteries, and the addition of the fixed .0005 mfd. condenser which seems to make the circuit easier to operate. The 2 mfd. condenser and the high-tension winding of the Ford spark coil are not necessary—they were put in to keep the direct current out of the loud speaker windings and thus avoid all chance of overheating them.

The filament current is limited to the desired value by making a proper combination of ordinary electric lights connected in parallel. A single 100-watt light will probably pass enough current for the filament of a 216-A tube. A 100-watt light with a 25- or even a 15-watt light in parallel will be enough for a VT-2 tube. A single 25-watt lamp is as much as can be used with a Radiotron UV-201-A or a Cunningham

Mr. Roberts, who is engaged in research work at the Palmer Physical Laboratory, Princeton, N. J., has been experimenting for some months with various systems of reception employing a single tube. His article, "A Single-Tube Loop Set in a Brief-Case," which was published in RADIO BROADCAST last month, describes a receiver weighing only six pounds, claiming everything. Although Mr. Roberts' claims for this portable set are very conservative, many readers have apparently become so enthusiastic that they are building, or planning to build, similar outfits for use this summer.

The batteryless loop outfit described this month will undoubtedly make a similar appeal to those who have long been wanting a loud-speaker set which could be operated on a loop without necessitating a prohibitive outlay of capital.—THE EDITOR.



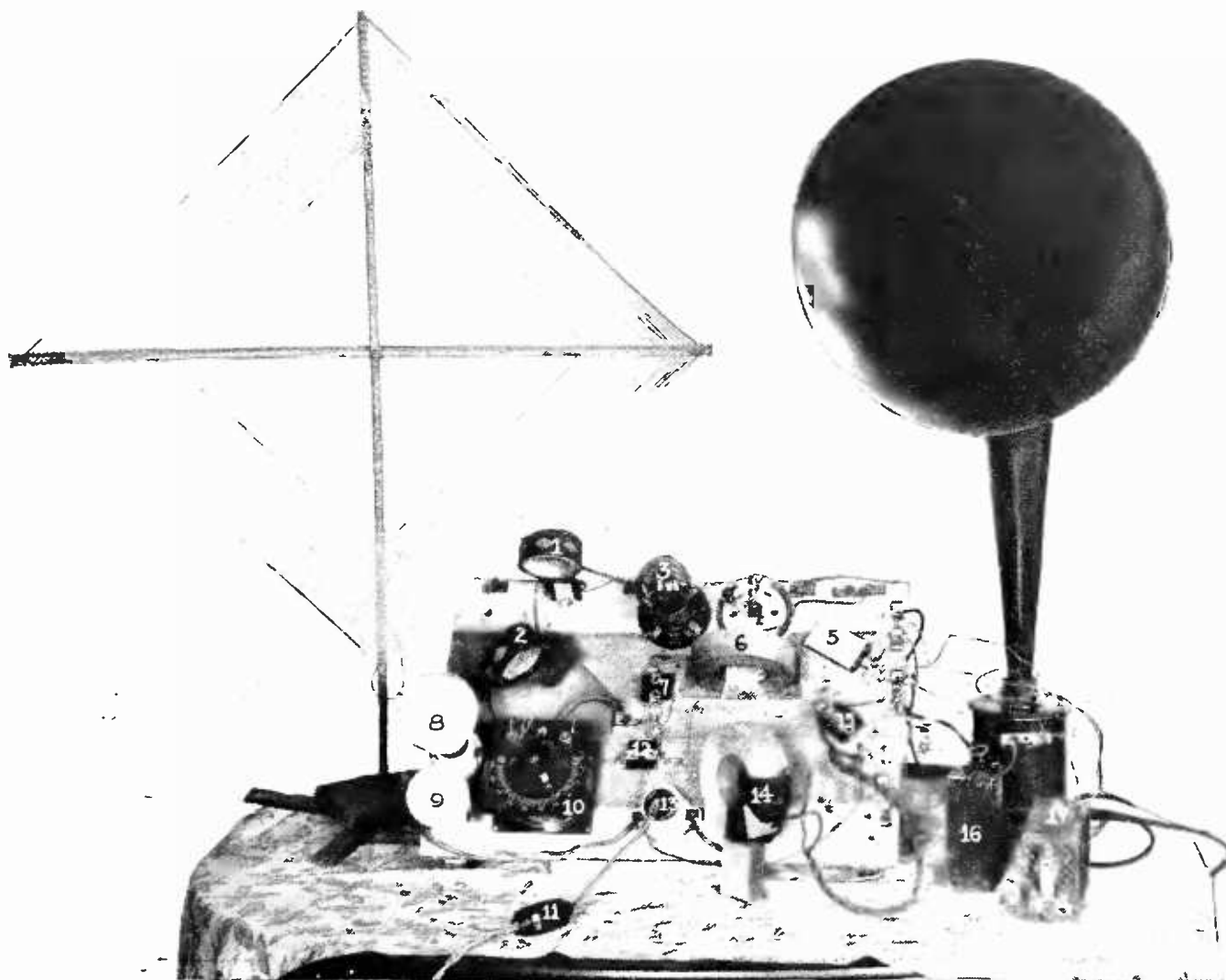

MR. ROBERTS' BATTERYLESS LOOP SET

The filament and plate currents are supplied from the ordinary D. C. house lighting circuit. 1 and 2, 75-turn multilayer coils; 3, Western Electric VT-2 tube; 4, 4-6 ohm rheostat; 5, .05 mfd. telephone shunt condenser; 6, 1250-turn multilayer coil, shunted by a .001 mfd. condenser (7); 8, 100-watt electric lamp; 9, 25-watt lamp; 10, .0005 mfd. variable condenser; 11, switch for turning on and off the 110-volt supply; 12, .002 mfd. condenser across the 1500-turn multilayer coil (14); 13, lamp socket which feeds the 110-volt current into the set; 15, .0005 mfd. condenser, connected directly across the interruption frequency circuit; 16, 2 mfd. condenser in series with the loud speaker; 17, Ford spark-coil, the secondary of which is used as a choke coil

C-301-A. It is not a bad idea to use a carbon filament lamp for the 100-watt lamp because carbon has a high resistance when cold and so gives the effect of turning the current on slowly. The variable resistance is an ordinary filament rheostat and is used to get a negative potential for the grid. It has very little effect upon the filament current.

#### ABOUT THE LOUD-SPEAKER

WESTERN Electric VT-2 tubes (also called "E" tubes) have proven very satisfactory. The Western Electric 216-A, used in that company's power amplifier should be equally good. A Radiotron 201-A or Cunningham C-301-A tube will work well with head phones

but will probably not give enough volume for the loud speaker. If the Western Electric 10-D loud speaker is used with the above mentioned W. E. tubes, the transformer in the base should be disconnected, which makes it equivalent to the 518-W loud speaker, which is the type supplied with the power amplifier.

For any one who likes to build apparatus and knows anything about radio, the foregoing remarks are sufficient. He can wind spider-web coils to avoid buying the small multi-layer coils and he can improvise his own means of varying the mutual inductance between both sets of coils. The writer prefers to spread all the parts out on a flat board where it is all in sight (though rather unsightly!) and to vary mutual

inductances by the simple process of sliding the coils around by hand.

For the benefit of any one wanting to try out this circuit without bothering to make up any parts or figuring out his own way of mounting them, the following instructions are given. It is assumed that the conventional arrangement on the back and front of a panel is desired. The constants of the circuit are the same as used by the writer for the past six months. They are satisfactory; but probably not the best: for instance, the Ford coil arrangement could be replaced with advantage by a properly designed step-down transformer.

A list of parts to be bought is as follows:

- One tube
- One socket
- One filament rheostat, 4 or 6 ohms
- Four sockets for ordinary electric lights
- One Ford spark coil or any other audio-frequency choke coil
- One fixed condenser, capacity 2 microfarads
- One fixed condenser, capacity .05 mfd (a Federal costs \$.50)
- Three fixed condensers such as Micadons, of capacities .0005, .001 and .002 mfd
- One Dubilier variable condenser, .0005 or .001 mfd. maximum.
- Two multilayer coils of 75 turns each
- One multilayer coil of 1250 turns
- One multilayer coil of 1500 turns
- Two double-coil mountings for these coils
- One loud speaker
- One loop aerial of about twice as many turns of wire as usually used on radio-frequency amplifier sets.
- One panel of any insulating material, 7" by 16" or more
- One cabinet, or brackets to support panel

Supply of binding posts, Fahnestock clips, screws, wire, etc.

#### CONSTRUCTION DATA

ON THE front of the panel (allowing a little space around the edges if it is to go in a cabinet) mount:

In the centre, along the upper edge, three electric light sockets sufficiently spaced so that a 100-watt light will go in alongside another light.

In the centre, at the bottom, the variable condenser, the whole thing being mounted on the front of the panel as this Dubilier "Variadon" is very thin.

At the bottom, to the left of the condenser, the knob of the rheostat, which is preferably behind the panel. The rheostat may be turned into the "off" position in lieu of a switch when not using the set.

At the bottom, to the right of the condenser, an electric light socket into which the plug carrying the 110-volt supply will be screwed when operating the set.

In the upper left and upper right hand corners, the two double-coil mountings, each being mounted so that the movable coil swings sideways away from the centre of the panel.

On the left edge, near the bottom, two binding posts or clips for the loop.

On the right edge, near the bottom, two posts or clips for the loud speaker or phones.

Behind the panel, mount:

The vacuum tube socket, just above the rheostat, being careful that the position is such that the filament won't sag toward the grid.

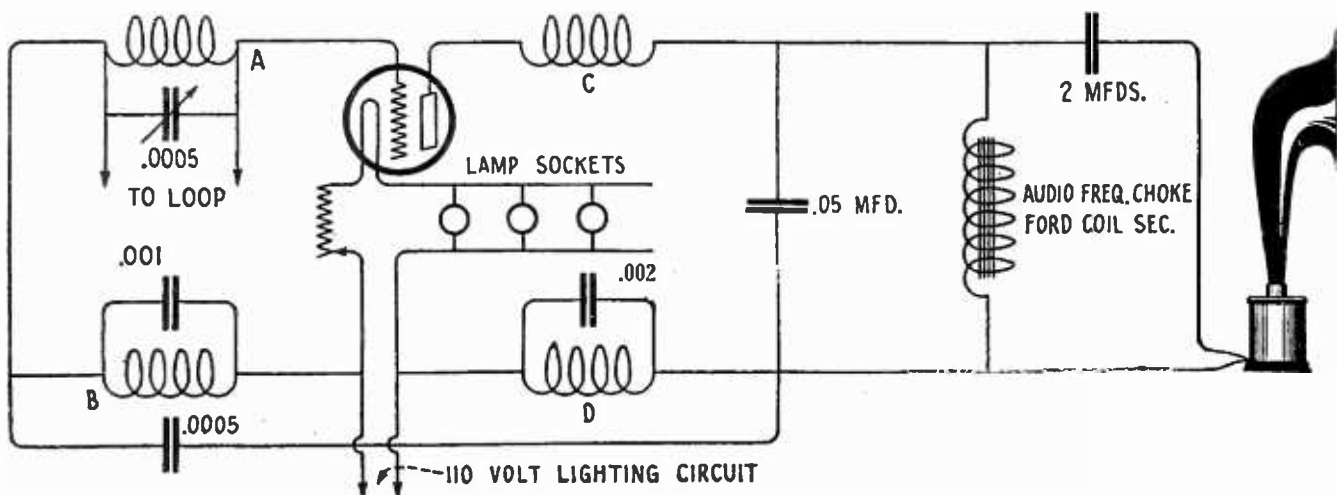

THE CIRCUIT ARRANGEMENT FOR THE ONE-TUBE LOUD SPEAKER LOOP RECEIVER

A and C are 75-turn multilayer coils; B is a 1250-turn coil and D a 1500-turn coil

Behind the right hand side of the panel, the Ford coil, the 2 mfd, and .05 mfd. condensers, in any convenient arrangement.

The small Micadons can be supported in mid-air by the wiring if it is stiff, or if any experimentation with different values is desired, they can be sprung between two Fahnestock clips whose flexible parts are flattened out and bent to stand out perpendicularly from the panel.

#### HOW TO MAKE IT "COOK"

THE wiring can be readily done by following the diagram, but even if this is done without error, there is only one chance in four that the set will work—at the first try. If it doesn't, swing both movable coils out as far as they will go, set the condenser at maximum, and touch both leads to the loop. If no click or very faint high whistle is heard, the 110-volt circuit is connected the wrong way around. This is easily remedied by reversing the points of the plug. Next, set the condenser at about half its maximum value and slowly move the tickler coil in. If a hissing noise is

not heard, the tickler coil is connected backward and the connections to it must be interchanged. Finally, when signals have been obtained with the 1500-turn coil swung way out, see if any improvement can be effected by bringing it in slightly. If not, reverse the connections to this coil also and thus find out which way it works best. (It is assumed that the tickler coil and the 1500-turn coil are the ones that have been mounted on the movable parts of the two-coil mountings.)

In operating this receiver, it may happen that when the tickler coil is brought in too close, the circuit will suddenly go dead. In that case, swing the tickler away a little and touch one of the leads to the loop. A very little practice will make any one familiar with the tuning of the set.

In concluding, the writer wishes to repeat that he is only giving values of capacities, coils, etc., that have worked, and that a few turns less on the tickler coil or loop, or a rearrangement of the coils and condensers in the interruption circuit, or a different kind of tube, may bring about improved results.

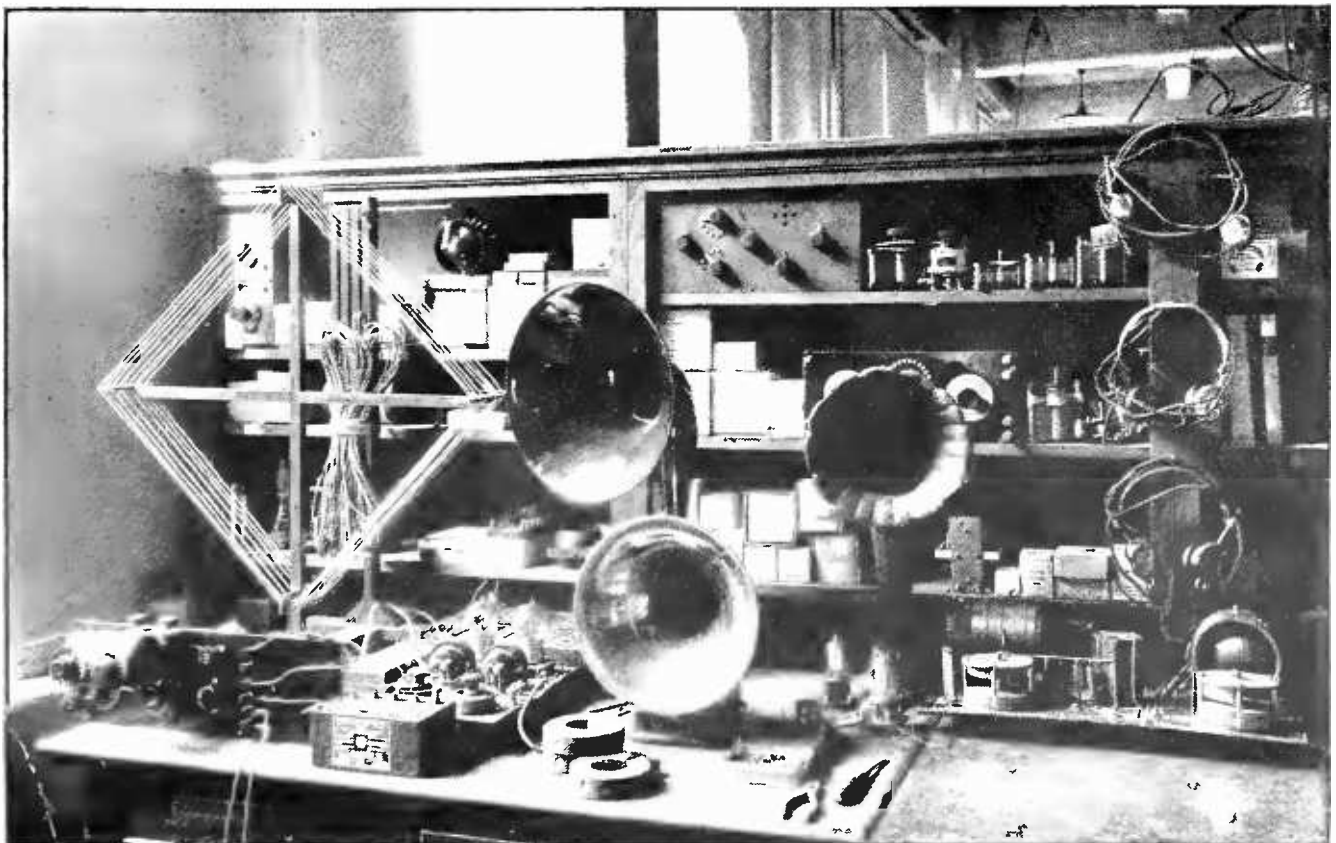

A CORNER OF THE OFFICE OF RADIO BROADCAST, SHOWING APPARATUS TO BE TRIED OUT  
It is our practice to test new circuits and new devices before recommending them to you

# A Stormy P. M. at Alice's

By WILLARD WILSON

I HAD come to call on Alice, and we were taking our tea with animal cookies—that is, she was. I was taking the cookies alone. I have always hated tea, it has such a slimy, greenish taste.

Alice had devoured a great amount of cookies and tea, and I had imbibed a fairly large herd of animals, but still the small tea talk wouldn't come. The atmosphere was getting horribly tense—you know—the way it is when a thunder storm is coming, and the static begins to buzz and whoop in your phones. Already I could see the preliminary flashes of lightning from Alice's eyes, and I began involuntarily to cringe and try to appear humble—and take it from me, that is not a hard job when Alice is about.

I had a pretty good idea of the cause of the oncoming tempest—I hadn't been up to see her or take her anywhere for a whole week. Heaven knows it wasn't my fault! I have a new Armstrong set and I had been mothering it for six days like an old hen, trying to get the blame thing to perk.

But about Alice. She began by gazing thoughtfully at the tips of her little shoes. Carefully she beheaded an elephant, then washed down the carcass with a draught of tea. Eventually she looked at me.

"Willy"—she knows I hate that name above all others—"Willy, where have you been all week?" Her voice was soft and cooing—it always is—but I quailed.

"Oh, I've been pretty busy——"

"Why, Willy!" She interrupted my nonchalant tone with an incredulous cry. "I thought you were having your vacation!"

I began to sweat a little at that, but managed to stave off my fate a little longer by swallowing a cow, a donkey, and two dogs. (It's funny that there are always more dogs in animal cookies than any other beast.) At the end of that operation I had concluded that the quickest way out for me would be to tell the truth.

"Alice dear—" I began bravely. But she cut me off short. The storm had burst, and she was in the first stage, where they get defiant.

"Don't 'dear' me!"—she said savagely. "If you don't care enough to come around once in a while——"

Here I interrupted her. "Now, Alice, please don't raise a row until you know what it's about." I was resolved to have at least a hearing, though I was perfectly aware that it would make not the slightest difference to her what it was about.

"I just got a new radio set," I explained carefully. She nodded her head viciously. I really believe she already knew it. But I went on patiently describing the weary hours I had spent tuning and experimenting—I tried to make it all sound very important—and then I began to discuss its merits. I had it going great



I MANAGED TO STAVE OFF MY FATE A LITTLE LONGER  
BY SWALLOWING A COW, A DONKEY, AND TWO DOGS

just the night before, so I guess maybe I did get a little over-enthusiastic.

"Why," I told her proudly, "Some day I expect to be able to hear program broadcasted from clear across the continent, then across the ocean, and then—" I became aware that she was not sharing my jubilation. Indeed, I saw that she was almost ready for the next stage. Her lip was beginning to tremble. That scared me. I haven't lived this long without learning some of the signs, and I simply cannot be brave in the face of hysterics. It makes me feel like a murderer or something. I never can tell what I'll do when a girl begins to cry.

"Now, now," I said, soothingly, panic tugging at my heart. Nervously I patted her hair. She has wonderful hair—so soft—and with a fresh, sweet smell like new-mown hay. Yes, it's bobbed. I don't know whether that is what makes the new-mown smell or not. But she wasn't quite ready to be soothed yet.

"B—Bill," she went on in that brave, plucky way she has—as if it is breaking her heart and yet she must finish what she has started—"after we are married, and getting o—old"—she moaned dismally—"will you spend all of your time listening to some old pup-pup-program?" She gulped convulsively and looked up at me.

Before I could answer, she presented her conclusive argument. She (speaking vaporically) switched her condenser. It is wonderful the amount of moisture and weeping that can come from two big, pleading eyes. I knew it would get me—it always does. In a moment all I could think of was how I could stop her crying. Frantically I racked my fevered brain for some new scheme, but before I had decided on any definite plan of action she was going again.

"B—Bill," she sobbed, "w-will you promise never to neglect m-me again for that—that old radio?"

"Yes! Yes!"—I promised wildly, distracted by her suffering, "I'll never look at a B battery again. I'll throw my phones out of the window. I'll smash up my—" She put her arm around my neck and cuddled down in my arms. I stopped my resolutions with a sigh of relief. I knew that the storm was over,



WOMEN ARE SO BLAMED INCONSISTENT

and somehow felt that I had gone a bit too far on the swearing off as it was.

A few moments later she lifted her rumpled head from my arms. "Billy dear," she said softly, "did you say it was an Armstrong set?"

"Yes," I answered, "an Armstrong Super."

"Is it made by the same company that makes Armstrong baking soda?"—she wanted to know.

I had never heard the names of the different kinds of baking soda—in fact I never even worked as a cook—and that question stumped me. I slowly swallowed a horse and a camel, then, like a true Californian, began to talk of the weather.

Alice didn't insist on an answer and in about three minutes she was as cool and sweet as a marshmallow sundae. She poured herself another cup of tea as if nothing in the world had happened—just after we had finished a scrap that could easily have turned our lives into different channels.

That's the dickens of it. Women are so blamed inconsistent! Alice was up at our house last night, and she wouldn't even take the receivers from her ears long enough for me to cut in on Arlington for the time signals.

# Learning the Code

Why All New Recruits to the Radio Game Will Find It Worth While to Learn the Radio Telegraph Code. How to Memorize the Alphabet, and How to Train Your Ear. Tips on Copying Code. The Use and Abuse of the Sending Key

By WILLIAM HARRIS, JR.

**Y**OU are one of these out-and-out enthusiasts, let us say, who falls under the general head of broadcast listener. Whether you are the kind of B. C. L. who will sit for hours enjoying the local programs, or (the other extreme) the kind who no sooner bags one brace of station calls than he is off on a hunt for more elusive game, is immaterial: you have a set and you think radio is great stuff and you want the ether waves to talk to you.

No doubt you have noticed that there are other stations in the air besides those that do the broadcasting. If you tune down below the concert range to 200 meters, you will be regaled with all sorts of interesting and unintelligible sounds, ranging in character from the growl

of a bulldog to the whistle of a peanut-roaster. These sounds would, of course, be far more interesting if they *were* intelligible—to *you*. You might listen to an amateur in Florida chewing the rag with a comrade up in Michigan whom he has known on the air for five or six years but has never seen. You might hear two fellows in neighboring towns come back and forth at each other almost as quickly as they could use the telephone, discussing some new hook-up, telling stories, or speculating as to the duration and intensity of the heat wave that's passing through the town where one station is located on its way toward the other, or aiding in the relay of a message from the Atlantic coast to the Pacific.

Then go up to 600 meters, if your broadcast



AN AUTOMATIC SENDER IS A GREAT HELP TO THE WOULD-BE TELEGRAPHER

He can turn it on at any time and receive code messages at any speed. This boy uses either the hand-key or the machine to operate the small buzzer shown on the key baseboard. By comparing his own sending with the smooth, perfect sending of the machine, he is able to improve his own "fist" very quickly

receiver will tune that high, and listen to the whines or the musical notes of the ship stations. If you could read code even at the rate of twelve words a minute, you might learn that that booming spark signal is advising the owners of S. S. *So-and-so* that their vessel is delayed six hours on account of heavy fogs but will reach port in the morning. Or the musical note may carry a radiogram from a passenger returning from Europe to his family: "Back to God's country to-morrow tell Mary to make one of her old-fashioned rice puddings love, Ed." You'd be surprised what choice bits a businesslike flock of radio code signals sometimes carries!

The amateur and ship traffic is not all that is of interest, by any means. Of course, your broadcast set will not take you up into the realm of the transatlantic stations—the high-power fellows that come in on a long-wave receiver clear and loud with a single tube. Your 360 to 400-meter outfit won't even go up near NAA's (Arlington's) transmission of time signals (12 noon and 10 P. M.), weather forecasts and news from all over the world. But once you have learned the code, you will probably want to buy, or assemble, yourself, a receiver for the longer waves.

Nor is listening-in on the world the only reason why it will be worth your while to learn the code. Thousands of amateurs will testify that the best sport of all is carrying on two-way conversations with other "hams."\* You may not care to undertake anything as pretentious as the installation of a station with a 500-mile transmitting range; but with a single tube and a simple home-built set you can call up a

### How to Get Your Transmitting Licenses

If you wish to transmit, you must have two licenses, one certifying you as an operator, the other for your station. You must be able to receive at least ten words a minute (five letters or characters to the word), and must comply with certain other requirements explained in the Government pamphlet: "Radio Communication Laws of the United States." It is advisable to obtain this pamphlet, as it gives a list of places where examinations are held and other information either necessary or helpful to the prospective operator. It may be had from the Superintendent of Documents, Government Printing Office, Washington, D. C. Price, 15 cents a copy.

friend who has a similar outfit down the other end of the street, or over in the next town.

But enough of this. If you are still unconvinced that learning the code will open a great new field of interest and enjoyment to you, just ask some dyed-in-the-wool amateur whether he's glad *he* learned it.

#### HOW TO ACQUIRE THE CODE

**B**EFORE attempting to do any receiving at all, you should memorize the code equivalents for *every one* of the twenty-six letters of the alphabet—memorize them so that you can lay the edge of a card over the code symbols on page 116, leaving the letters showing, and repeat to yourself correctly each letter, checking up each time by looking at the correct code equivalent. Take a few letters first—for example, A through F—and "get these down cold." It is easy to improvise simple ways of associating, in your mind, each combination of dots and dashes with

its letter, ways which will last you until the code is ringing in your head, until **—•••** means B immediately, not "dash, three dots." Leave these six letters and take the letters from G through M. Then review what you have memorized so far and you will have learned thirteen letters—half the alphabet! If you are exceptionally keen, and buckle right down to the job, half an hour's study will give you all the letters; and even if you are only an ordinary mortal, like the rest of us, you should not need more than, say, three or four periods of study of a half hour each.

When you have no one to help you, here is an excellent way of drilling the code into your memory: cover over the code symbols in the list and ask yourself what A is, what B is, etc. Each time you don't know, write the letter you missed on a slip and turn it face down: if you can't think what F is, for instance, put an F slip aside. (It might be well also to put aside one whole alphabet.) Then draw your slips,

\*Those who are interested in building their own transmitting sets will be interested in the series of articles by Zeh Bouck, "Simple Bulb Transmitters," which appeared in **RADIO BROADCAST** from November, 1922 to March, 1923, inclusive. For a low-power, inexpensive and ingenious arrangement, see "Transmitting and Receiving with the Same One-Tube Set" by Frederic W. Proctor in the May, 1923, number.

# INTERNATIONAL MORSE CODE AND CONVENTIONAL SIGNALS

A . —  
 B — . . . .  
 C — . — . .  
 D — . . .  
 E .  
 F . . — . .  
 G — . — .  
 H . . . . .  
 I . .  
 J . — — — —  
 K — . — .  
 L . — . . .  
 M — — —  
 N — . .  
 O — — — —  
 P . — . — .  
 Q — — — — .  
 R . — . .  
 S . . . .  
 T — — —  
 U . . . . .  
 V . . . — .  
 W . — — —  
 X — . . . .  
 Y — . — — —  
 Z — — . . .

Ä (German) . — . — . —  
 Á or À (Spanish-Scandinavian) . — . — . —  
 CH (German-Spanish) — — — — —  
 Ê (French) . . — . . . .  
 Ñ (Spanish) — — — — —  
 Ö (German) — — — — .  
 Ü (German) . . — — —

1 . — — — — —  
 2 . . — — — —  
 3 . . . — — —  
 4 . . . . —  
 5 . . . . .  
 6 — . . . . .  
 7 — — . . . .  
 8 — — — — . .  
 9 — — — — .  
 0 — — — — —

Period . . . . .  
 Comma . . . . .  
 Interrogation . . . . .  
 Exclamation point . . . . .  
 Bar indicating fraction . . . . .  
 Parenthesis . . . . .  
 Distress call . . . . .  
 Attention call to precede every transmission . . . . .  
 General inquiry call, (C Q) . . . . .  
 From (de) . . . . .  
 Invitation to transmit (go ahead) (K) . . . . .  
 Question (please repeat after interrupting long messages) . . . . .  
 Wait (A S) . . . . .  
 Break (Bk.) (double dash) . . . . .  
 Understand . . . . .  
 Error . . . . .  
 Received (O. K.) . . . . .  
 Position report (to precede all position messages) (T R) . . . . .  
 End of each message (cross) . . . . .  
 Transmission finished (end of work) (conclusion of correspondence) . . . . .

1. A dash is equal to three dots.
2. The space between parts of the same letter is equal to one dot.
3. The space between two letters is equal to three dots.
4. The space between two words is equal to five dots.

one by one. If you know them all, well and good; if not, learn the letters you missed, then and there, and put those slips aside to form a new pile. By this process of running over and over the letters you don't know, you will arrive at about half a dozen—J, Q, X, and Z will probably be among them—which will

represent your temporary Waterloos. Go at these few, and *get them*—till you know them as well as you know A and E. Following this, review the whole alphabet once or twice and call it a day. But keep the slips for the next set-to. They may seem like a reversion to kindergarten days; but they can help you



a great deal. The principal advantage this system has over any hit-or-miss method is that you learn the so-called "difficult" letters thoroughly. Later on, when you hear **—••••** or **—••••** you won't mentally curl up and die, as so many beginners do, missing the next four or five letters before you determine that the **—••••** was a P and the **—••••** a Q. For some reason, F and L are

regularly confused by those who are learning the code. Take these two aside and have it out with them: they will never bother you again.

We shall suppose that you know, now, what the code sound for each letter is—when you stop to think. (Call them "dits" and "dahs," not dots and dashes; it helps considerably to give your ear the distinction between the short and long code units). If you can get someone to send to you with a buzzer outfit, while you sweat away with paper and pencil, you should make very rapid progress. Be sure to make him send *always a little faster than you can take*. If he sends too slowly, your attention will wander; if too fast, you will not copy enough to keep yourself encouraged. At first, it is advisable to take chiefly five-letter cipher words—*xebjr, otnla*, etc.—or else ordinary words sent backward. The reason for this is that if you think you know what is coming, you will "anticipate"—either writing down letters before they are sent (and one is often fooled doing this) or by "getting set" in your mind for a certain letter, thus making it harder for yourself to receive correctly a different one.

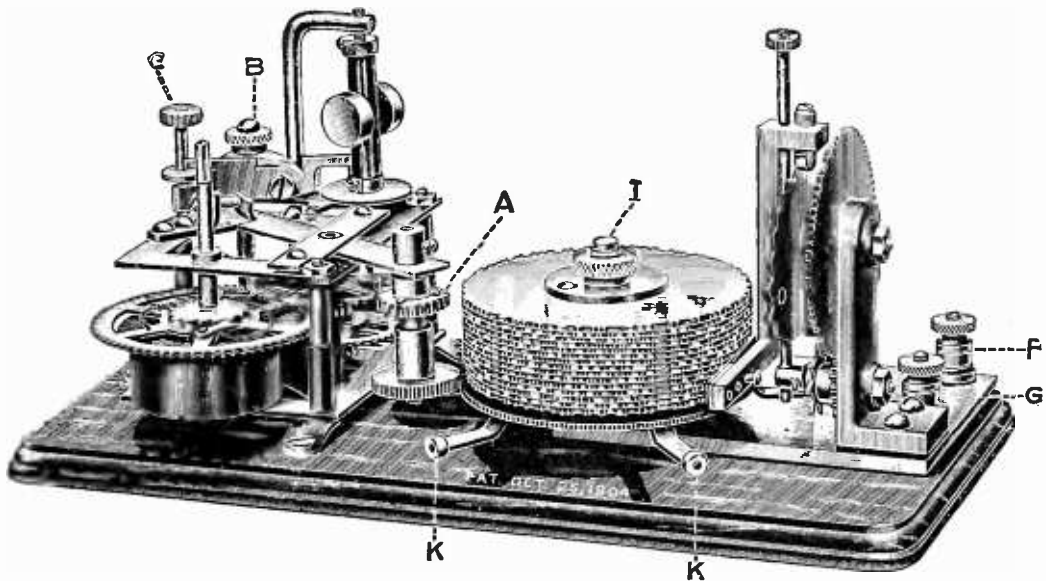

THIS OMNIGRAPH WILL RUN OFF 1200 WORDS ON ONE WINDING  
C regulates the speed—from 5 to 50 words a minute; I is a thumbscrew for changing the dials; K, K, are message changers, which may be operated while the machine is sending

Perhaps it is impossible or difficult for you, in this period of your code development between the alphabet and the copying-slow-press stages, to get someone to send to you. In this case, you can have recourse to either the omnigraph or the phonograph. The omnigraph is an instrument actuated by a coiled steel spring, which, when connected in circuit with an ordinary buzzer and dry cell, makes and breaks contacts according to the raised dots and dashes on its one or more revolving discs. You may think that after a while you would know the omnigraph's repertoire by heart—at least, the words that "make sense"—but it is safe to say that by the time you know the jumbled code letter groups by heart, you will be ready to copy some of the real thing, anyway. Plenty of it is always waiting for you in the ether, ready to have you interpret it when you have the means. A set of six Victor records (12 lessons) can be bought, if desired, which will send all kinds of code to you, at every speed and under various conditions (the more advanced records, for instance, including many realistic bursts

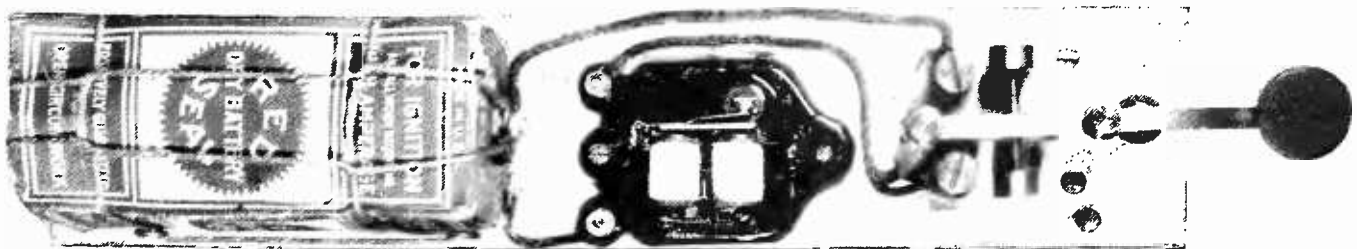

A CONVENIENT WAY TO MOUNT YOUR BUZZER PRACTICE SET



THE PROPER WAY TO HOLD THE KEY

of static and one or more "other stations," to give you practice in copying through interference).

#### A SIMPLE PRACTICE SET

A CONVENIENT way of mounting the three units needed for a practice buzzer outfit is shown at the bottom of page 117. The dry-cell will cost you about 45 cents, the buzzer about 35 cents, and the key anywhere from 0 to several dollars. It will be 0—and just as satisfactory when you are learning the code—if you use simply a strip of springy metal, with a hole in one end, which makes contact with a screw head at the other. A Meccano toy building strip is just the thing. High-frequency buzzers, giving a two-dollar mosquito-like note, may be used if desired, although the 35-cent bark of the ordinary house buzzer is music enough to the ears of most beginners.

A word about sending—but I might as well say "a word" about how to drive a golf ball two

hundred yards. Different operators have different styles, and all of them require a certain amount of practice before being able to send smoothly. Some operators do it all with the wrist, with such a flexibility that the hand "posts in the saddle" like a rider at a trot. Others "fists," no less skilful, roll from side to side when they get warmed up, like a ship at sea. But no good operator lifts his hand off the key while sending, or pecks at the key like a chicken after corn. The most generally accepted method

of holding the key is indicated in the accompanying photograph. Thumb on the side of the key-knob for steadying, first finger on top for applying the downward pressure, and middle finger below, to steady the hand and to give the necessary upward pressure when the key contacts stick (as frequently happens when a heavy current is used). The more you use your wrist in sending, rather than your fingers, the less cramped your hand will be. In this respect, what is true of penmanship is true of telegraphy.

You know the kind of fellow who always drives a car as fast as he can, faster than safety permits; and the kind who always talks loud and long, no matter what other people may have to say. These types are found, alas! in the radio game as well as elsewhere. The first type sends out a jumble of rushed and mutilated signals; and the second jams the air with endless calls, tests, or "bull." Having mentioned these horrible examples, need more be said?

## What Would You Like to Have in Radio Broadcast?

*The editor would be pleased to hear from readers of the magazine on the following (or other) topics:*

1. *The kind of article, or diagram, or explanation, or improvement you would like to see in RADIO BROADCAST.*

2. *What has interested you most, and what least, in the numbers you have read so far.*

# Is Short-wave Relaying a Step Toward National Broadcasting Stations?

Listeners-in in Cleveland, Ohio, Now Hear Pittsburgh as Distinctly as They Hear Local Stations, by a New Method of Broadcasting

By W. W. RODGERS

Westinghouse Electric & Mfg. Co.

Re-broadcasting is a system of transmitting on a certain wavelength, picking up the signals at a remote point, and using the received energy—amplified locally—to actuate other broadcasting transmitters on one or more different wavelengths.

The possibilities of re-broadcasting are indeed staggering. A central station, located in Washington, for example, could carry the voice of the President to listeners in every section of our country if re-broadcasting, as described in this article, were properly fostered. That is a large order, but we shall undoubtedly see its realization by this or some similar system before long. This article by Mr. Rodgers is the first to appear on this very interesting development.—THE EDITOR.

**P**ERHAPS there is no phase of broadcasting that appeals to all of us more than the establishment of national broadcasting stations—just a few of them distributed carefully at selected centres throughout the country so that they serve all sections in a satisfactory manner. One large station, for instance, might serve the public within a radius of 500 miles, and enough of these stations could be established, under government regulation, so that no one within these circles would lack entertainment—or get too much of it on interfering waves.

The present trend in radio seems to indicate that the national broadcasting station will help to solve some of the most important broadcasting problems.

Already, the Westinghouse Electric & Manufacturing Company has successfully relayed concerts on 80 to 100-meter wavelengths with results that warrant further research along this line. Programs from KDKA, the company's broadcasting station at East Pittsburgh, have been relayed from its experimental station, KDPM, in Cleveland, Ohio and from WBZ, in Springfield, Mass. In both these cities, KDKA's concerts have been received with great clarity, even though Cleveland is one of the so-called "dead" spots of the country.

Short-wave relaying and the establishment of national broadcasting stations are, therefore, pertinent subjects in which every radio fan, engineer, and manufacturer should be vitally

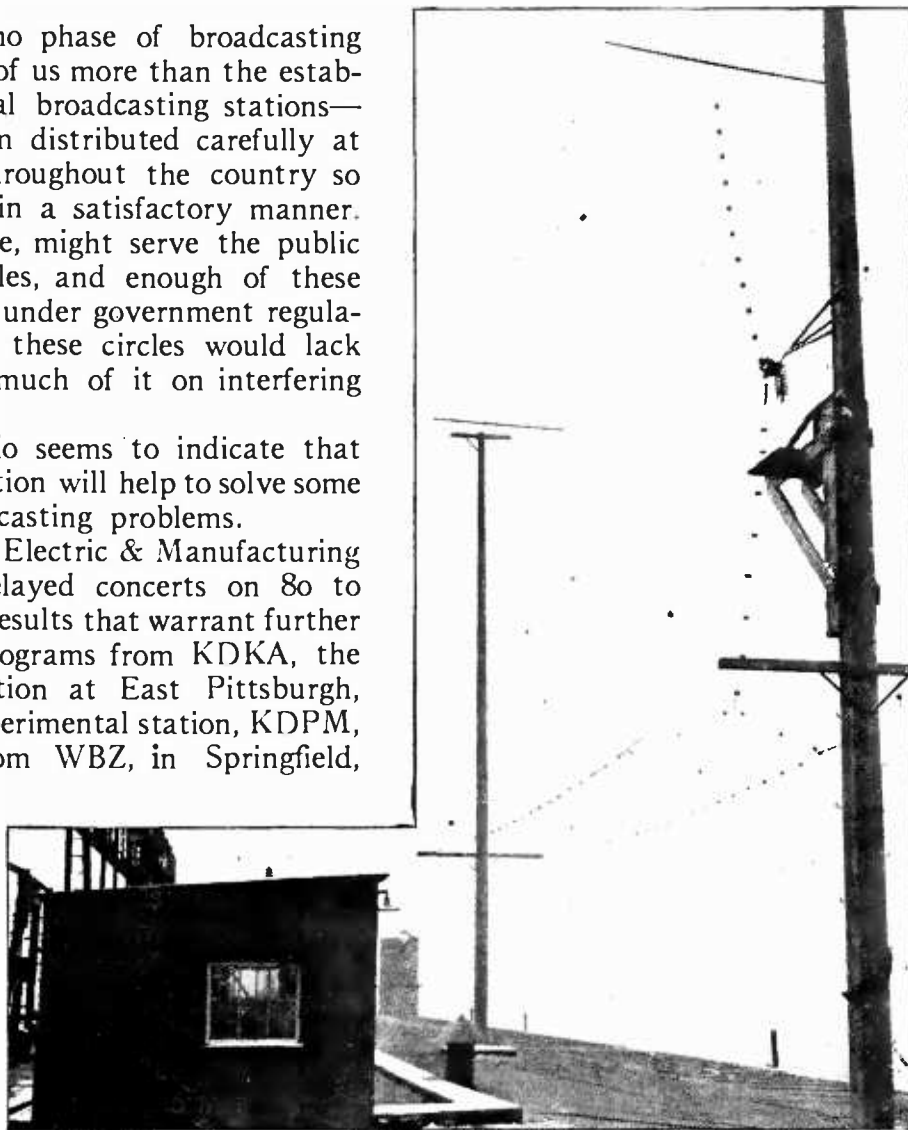

THE SHORT ANTENNA USED FOR 100-METER TRANSMISSION  
Erected at KDKA, East Pittsburgh, Pa.

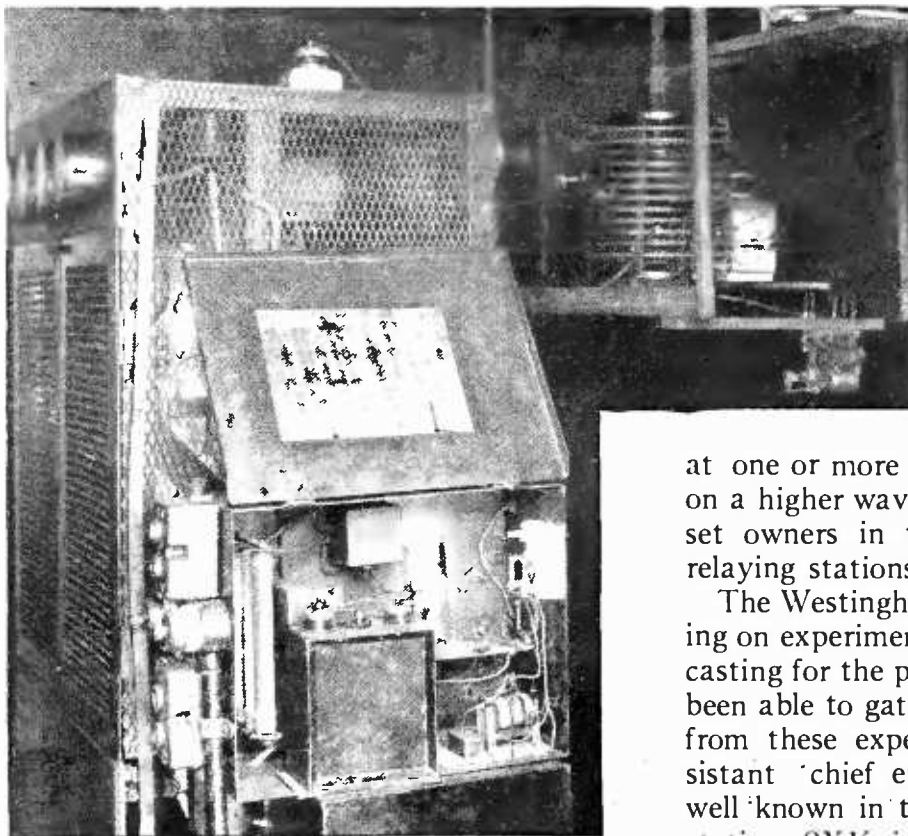

THE 100-METER VOICE AMPLIFIER AT KDKA

interested. Mr. H. P. Davis, vice-president of the Westinghouse Company, is said to be the first to suggest national broadcasting. His plan involves: "The establishment of radio broadcasting on the same basis as other public utilities, with an Interstate Radio Commission and, therefore, a Federal Commission created by presidential appointment. This commission would be vested with full power and authority to make regulations and enforce them to the full extent. A transmitting license would then take on the nature of a franchise because of the large expense necessary in establishing a high-class station. There would be established two classes of broadcasting stations. First, the stations national in scope, and second, local stations serving particular districts. The local stations could be made non-interfering by the allocation of different wave bands."

This plan, of course, must be worked out in all its various phases, a task requiring great attention to details and the solving of many engineering problems incidental to its perfection. One difficulty, which has possibly already occurred to you is the fact that the small receiving set, especially if it is of the crystal detector type, would be unable to pick out the long-distance stations, and would therefore be

quite out of the radio world. Here is where short-wave relaying supplies the missing link between the large national station and the small receiver.

Just what is the plan of short-wave relaying? Briefly, it is the broadcasting of programs on a wavelength below 100 meters, to be picked up

at one or more distant stations and relayed on a higher wavelength to serve the receiving-set owners in the districts surrounding the relaying stations.

The Westinghouse Company has been carrying on experiments with this method of broadcasting for the past year and has, in that time, been able to gather a great deal of useful data from these experiments. Frank Conrad, assistant chief engineer of the company, and well known in the radio world because of his station, 8XK, is believed to be the man who first experimented with broadcasting on these very short wavelengths. Before Mr. Conrad got into the work, radio engineers had proved by mathematics that transmission on short waves was impracticable, but he had an idea that their calculations might not be correct, and decided to investigate for himself the possibilities of broadcasting effectively on wavelengths of 100 meters or lower. First, he built a set to transmit on 100 meters and found by tests with an amateur operator in Boston that the 100-meter wavelength was more selective and more efficient than even 360 meters. Mr. Conrad next arranged for a private telephone connection between Station KDKA and his home, about four miles distant, and by a special circuit arranged to receive programs from the studio circuit over his telephone line. He then connected this telephone line to his 100-meter transmitting set and sent out KDKA's programs simultaneously with the broadcasting on 360 meters.

In Boston and other places it was reported that this transmission was stronger than the signals received directly from KDKA on 360 meters! This was true, even though his station was much less powerful than the one at East Pittsburgh.

With these facts in mind, the Westinghouse radio engineering department decided to try

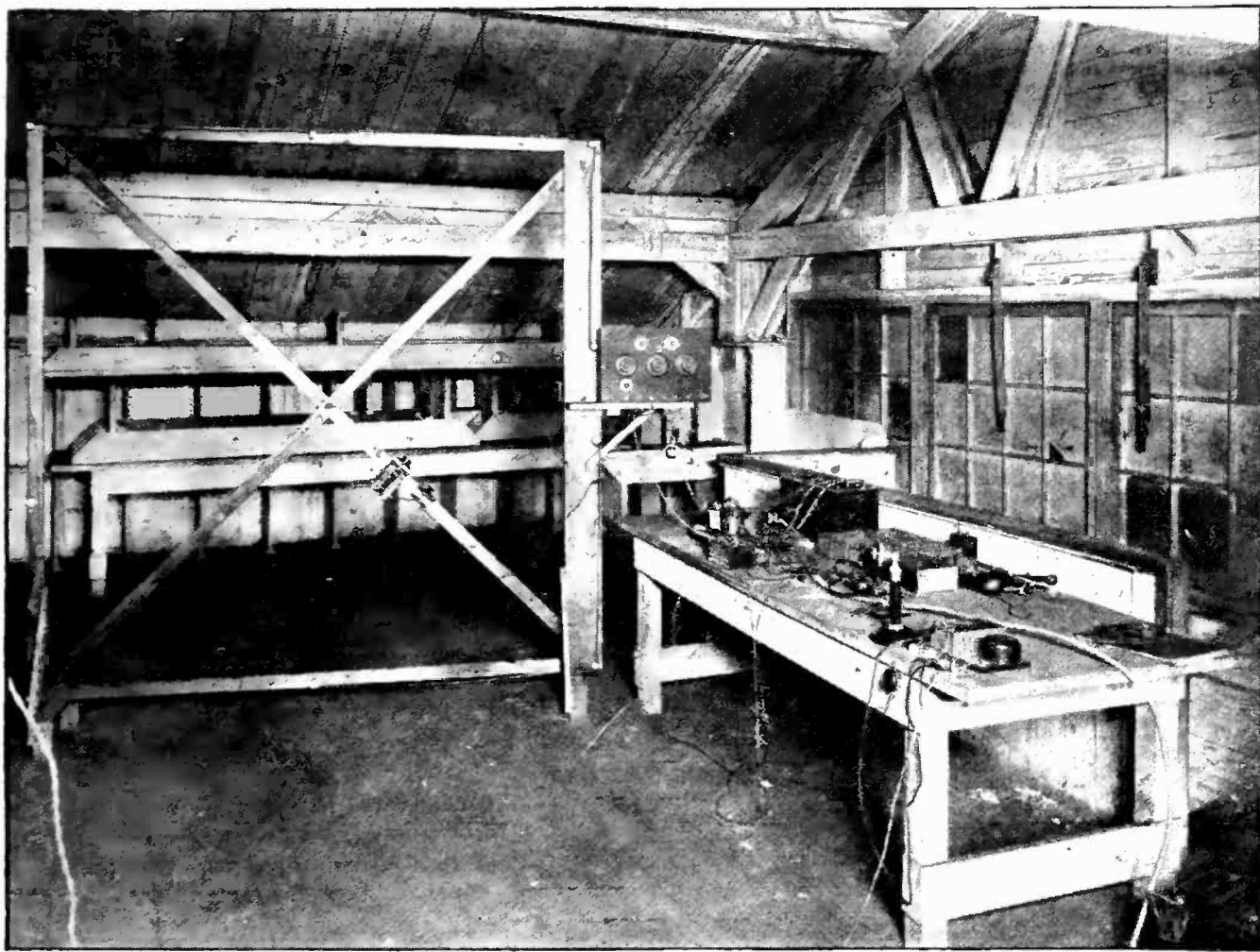

THE LOOP-AND RECEIVING SET AT THE CLEVELAND STATION, KDPM

This is where the broadcasts, sent from KDKA on 100 meters, were received

experiments with Cleveland, where the broadcasts from KDKA on 360 meters, had never been satisfactorily received. To that end a relaying station was established in the Cleveland Foundry, located on the Lake end of West 58th St., and the short-wave relaying tried out. It was not long before Cleveland fans were reported receiving signals from KDKA with the same volume as they were receiving local broadcasting.

The same thing is now going to be tried out in the Springfield station as an adjunct to the programs broadcasted from WBZ.

The mechanics of relaying presented a great many problems which had to be worked out gradually as they presented themselves.

In order to carry on this short-wave relaying, it was thought best to employ two transmitters controlled from the same microphone, one transmitter operating on 360 meters, the other on 100 meters. This was done and now there are also two antennas—KDKA's long antenna

which is 105 feet high and 200 feet long, used for broadcasting on 360 meters, and the short-wave antenna which is 35 feet high and 40 feet long, used, of course, for sending the 100-meter signals.

In Cleveland, the 100-meter signals are received on a loop eight feet square, for the reason that the ordinary inverted L antenna might throw the receiving station out of tune if it swung in the wind. This antenna is located inside the building and is connected to a single-circuit detector unit, with two stages of amplification. The output of the receiver is delivered directly to a 250-watt transmitting set, containing one oscillating and one modulating tube. The transmitting antenna is duplicate of the one at East Pittsburgh used for sending on 360 meters (105 feet high and 200 feet long.)

Naturally there are difficulties encountered in relaying these short-wave signals. For instance, the small size inductances and capacities are difficult to construct. A slight

change, like the swinging of the antenna, will change the wavelength and throw the receiver out of tune. On the other hand, the efficiency on 100 meters or lower is comparatively high, on account of the lower electric losses which permit greater radiation from a given antenna at the same power input than is possible when sending on 360 meters.

Perhaps the principal reason why short-wave broadcasting will prove important in future radio telephone stations is that it will open up a great range of wavelength bands. This is, of course, irrespective of the possibilities of national broadcasting. For instance, there are only 25 wavelength bands, each 10,000 cycles wide, between 300 and 400 meters, whereas there are 300 such bands between the wavelengths of 50 to 100 meters. This fact may lead to the solution of the interference problem that confronts broadcasting as we know it to-day.

There are other things to be taken into consideration which show that the lower wavelengths have some very desirable characteristics. It has been observed that static is less noticeable than on 360 meters. This was found to be true when the same concert was heard simultaneously on 360 meters and 100 meters. A dash of static that would completely drown out the 360-meters broadcasting would scarcely be noticeable on the 100-meter wavelength.

Another advantage, indicated by these tests is that daylight does not reduce the range of the short-wave broadcasting as it does when the 360-meter wavelength is used. At direct variance with the system in use to-day, first tests have shown that daylight transmission is materially better than night transmission at a wavelength of 80 meters. It is believed, though still unproven, that there will not be the falling off in distance in the summer time which is one of the handicaps of broadcasting at present.

There are, to be sure, some drawbacks to broadcasting on extremely short waves. The most serious is that the receiver gets out of tune very easily. This is frequently due to the swinging of the antenna, but this sort of trouble could be easily reduced by using some sort of fixed antenna, or a loop such as is used at KDPM.

Mr. Davis has already suggested the relaying, by stations of limited power, of concerts broadcasted from a powerful central station, so that the whole country might listen to the same concert. That such a plan is feasible for a comparatively small area, the Westinghouse Company's experiments have proved; and since the theory itself is known to be sound, it seems that the development of a national broadcasting system can be a matter of only a few years.



#### ANOTHER "CAVE MAN"

Mr. N. M. McCoy, of Monmouth, Illinois, sends us this picture, and says: "Talk about cave-man stuff—how does this set look to you? Cigar boxes nailed on a board, for a panel. Have listened-in on most every station from Minneapolis to Atlanta and from Newark to Dallas! I enjoyed Mr. Tannehill's article. [RADIO BROADCAST for February, 1923] very much and have had all his experiences and then some. He says: 'buy your parts, tie them together, part your hair in the middle, and go after Havana.' I can't part my hair in the middle; but I have seen the time when if the second hand on my watch had stopped I know I would have made the station."

# The Best Battery Connections for the Circuit You Use

Perhaps Your Tubes Are Not Working at Their Best. Different Arrangements of A and B Batteries are Necessary for Best Operation of a Tube When Used as Detector and When Used as Amplifier. Check Up Your Own Circuit

By EDWARD LINDLEY BOWLES

Instructor in Electrical Communication, Massachusetts Institution of Technology

AT THE present time, there seems to be much confusion in the arrangement of A batteries in vacuum-tube circuits. One detector circuit may be shown with the grid connected to the positive side of the A battery, whereas another detector circuit of the same nature may be shown with the grid connected to the negative side. The same is true in the case of audio-frequency amplifiers. And the negative terminal of the B battery is usually connected to the negative side of the A battery for no apparent reason other than that it is the custom.

In many descriptions of circuits, the reader is confronted with the expression "at zero grid potential," or "with a grid potential of minus 1 volt"—another means of expressing the same thing—or "a negative bias of 1 volt." One may well question the exact meaning of these terms, if the grid can be arbitrarily connected to the positive or negative side of the A battery.

In order that the characteristics of a vacuum tube may be clearly defined, it is customary to state them in terms of connections made to the negative side of the A battery. In this way, you can clearly understand that if the grid of a vacuum tube is said to have a negative potential of 1 volt, it is 1 volt more negative than the side of the filament connected directly to the negative terminal of the A battery. But here

again a question may arise, for circuit drawings are shown with the filament rheostat sometimes in the positive, sometimes in the negative, side of the filament circuit. If the filament rheostat is in the negative filament lead, then, even though the grid is connected to the negative

side of the filament battery, it is not at the same electrical potential as the negative side of the filament. In actual practice, there are sometimes certain advantages in placing the filament rheostat in one particular side of the filament circuit. Again, there may be particular advantage in connecting the grid to a particular side of the filament battery. The reasons for special arrangements of connections to the A and B batteries can be

## Do You Know:

Why a rheostat is placed in the positive filament lead in some circuits and in the negative lead in others?

Why the negative terminal of the B battery is sometimes connected to the positive and sometimes to the negative terminal of the A battery?

What determines your grid potential, and what effect has it on your circuit?

Why a potentiometer is used with a "soft" detector tube such as the UV-200, and not with the WD-11?

How to make the proper connections for various tubes used as detectors and amplifiers?

If not, this article will be of interest and value to you.

Keep it handy.—THE EDITOR.

made clear by a few simple diagrams.

In Fig. 1, a vacuum tube is shown with all batteries connected. The voltmeter, in the grid circuit (Fig. 1) indicates the potential of the grid with respect to the negative end of the filament. When the grid is connected directly to the negative end of the filament, that is, when the C battery is removed from the grid circuit and the point M is directly connected to the point N, the grid is said to be at zero potential. It must be remembered that it is at zero potential only with respect to the point H of the filament. The point K of the filament is more positive than the point H, since it is closer to the positive side of the A battery.

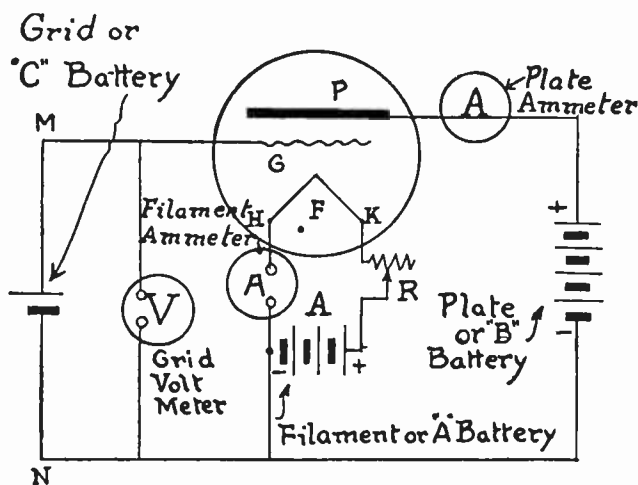

FIG. 1

The fundamental vacuum-tube circuit from which plate, grid and filament voltages for the proper operation of various types of tubes may be ascertained

Whenever the characteristic curves of vacuum tubes are referred to, they are obtained by the standard connections shown in Fig. 1.

It does not follow, from this discussion, that the connections of the batteries shown in Fig. 1 are best for practical applications of the vacuum tube. Where a hard tube is used as a detector it is unnecessary to connect the negative side of the B battery to the negative side of the A battery. Very often it is of advantage to connect the negative side of the B battery to the positive side of the A battery so as to have the advantage of augmenting the B battery voltage by the A battery voltage. Also, it is usually more satisfactory to connect the grid of the detector tube to the positive side of the A battery, because a detector tube usually works best when the A battery tends to make the grid slightly positive. Connections for a hard detector tube, such as the UV-201-A, the WD-11,

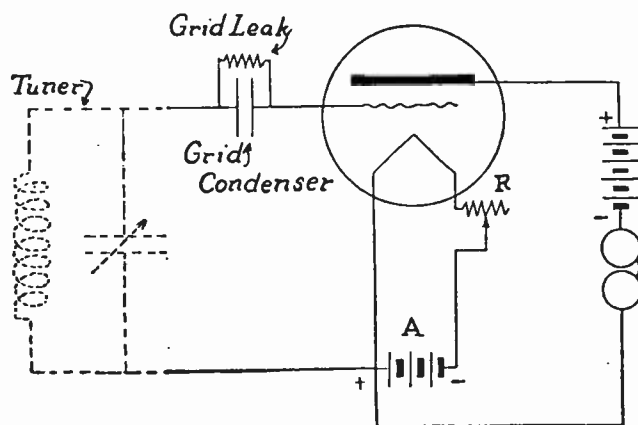

FIG. 2

When a hard tube such as a WD-11, C-300, C-301-A, UV-199, UV-201, or UV-201-A, is used as a detector, this circuit arrangement may be used

or the VT-2, are shown in Fig. 2. In this case, the grid is connected to the positive side of the A battery. The plate, or B battery, is also connected to the positive side of the A battery, and the filament rheostat R is placed in the negative side of the filament. In this way, any variation in the filament current does not affect the potential of the grid as much as if the filament rheostat were placed in the positive filament lead.

Figure 3 shows a detector circuit arranged for using a soft detector tube, such as the UV-200. In this case the grid is once more connected to the positive side of the A battery and the rheostat is placed in the negative filament lead. Since this type of tube is very sensitive to a change in plate voltage, a potentiometer, P, is inserted as shown. Under these conditions, if an 18-volt tap is taken on the B bat-

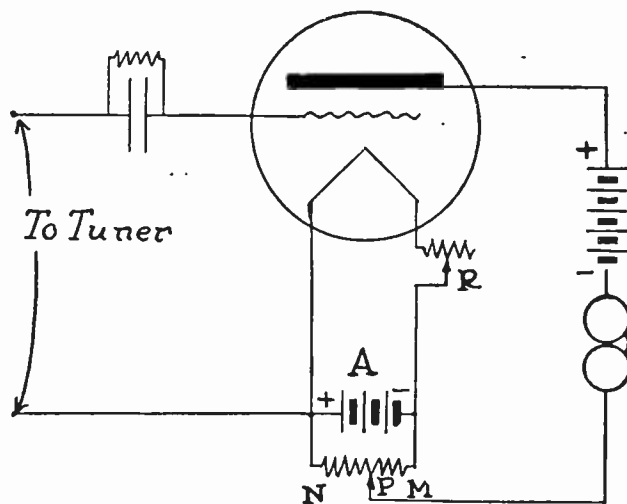

FIG. 3

When using a soft detector tube, such as the C-300, UV-200 or some of the old De Forest, Audiotron and A-P tubes, this circuit arrangement is better than the detector circuit shown in Fig. 2

tery, then if the potentiometer slider is at the point N, the plate will have a potential of 24 volts (if a 6-volt A battery is used). When the potentiometer slider is at the point M; the plate will have a potential of about 17 volts (owing to a drop of about 1 volt in the filament rheostat). By this arrangement the plate potential can be adjusted to an optimum operating value, as required by the particular tube in the socket.

In the case of an amplifier, the problem is a different one. As long as the grid of the amplifier tube is positive, distortion will take place. In fact, in many cases it is necessary to give the grid a decided negative potential, with respect



to the most negative end of the filament, in order that efficient and relatively distortionless amplification may be obtained. It is also of advantage to operate an amplifier tube at a higher potential than a detector tube. Therefore, the negative end of the plate battery might just as well be connected to the positive side of the A battery in order that the plate voltage may be augmented by that of the filament battery.

Figure 4 illustrates the connection of the A and B batteries in the case of an amplifier tube. The grid connects to the negative side of the A battery. The filament rheostat R is also placed in the negative side of the filament battery. The negative side of the B battery is connected to the positive side of the A battery. The insertion of the filament rheostat in the negative side of the filament has the advantage of giving the grid a slight negative potential. In fact, if a 6-volt A battery is used, where the actual filament voltage required is only 5, there will be a 1-volt drop in the filament rheostat. This means that the point D is one volt more positive than the point E, which is the most negative point on the circuit. An audio-frequency amplifier will operate better with the filament rheostat in this position, since the grid will be automatically given a slight negative bias. The disadvantage which attends this arrangement lies in the fact that, as the A battery discharges, less and less of the rheostat resistance is required. When the A battery has reached a potential, let us say, of that actually required by the tube itself, then all the resistance will have been cut out of the rheostat and the grid will have no negative potential or "bias."

Many commercial amplifiers, either radio-frequency or audio-frequency, cannot incorporate this arrangement having a filament resistance inserted in the negative side of the filament lead, because there are certain patents, held by one of the large corporations, which preclude the use of it.

Another arrangement for an amplifier circuit is shown in Figure 5. In this case, a C or grid biasing battery is used, so that the grid may be given any negative potential desired simply by inserting the proper number of cells in the C battery. Flashlight cells are very convenient for this purpose, because of their small size. The approximate electromotive force of such cell is  $1\frac{1}{2}$  volts. Cells used in the C battery should be placed as close to the A battery as

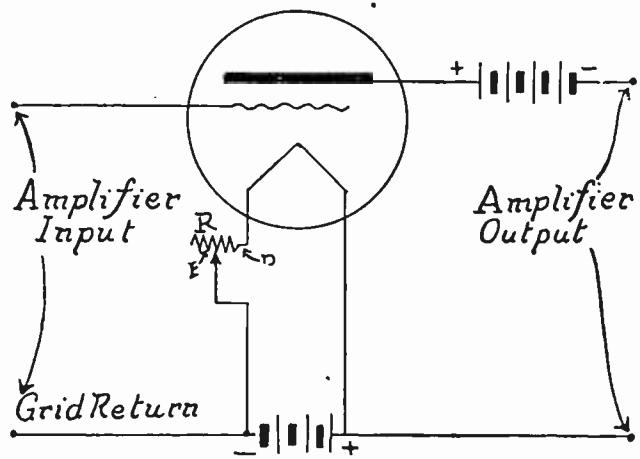

FIG. 4

In amplifier circuits, hard tubes should always be used and this circuit arrangement may be used to advantage. A negative bias, equal to the voltage drop across the filament rheostat, is automatically imposed on the grid. If the A battery is kept well charged, the use of a C battery is usually unnecessary where this circuit is employed

possible, and should not be placed near the grid, as shown by the point H.

Various tubes require various negative biases when used as amplifiers. The new 201-A tube requires from -0.5 to -5 volts, depending upon the plate voltage. The Western Electric VT-1's require from 0 to -3. The Western Electric 216 -A tube, which is used in the W.E. power amplifier, requires a bias of approximately -6 volts, and the WD-11 requires a bias of from 0 to -4.

Figure 6 shows the use of a stabilizer or potentiometer. By the use of this device, the grid bias may be varied when the tube is under

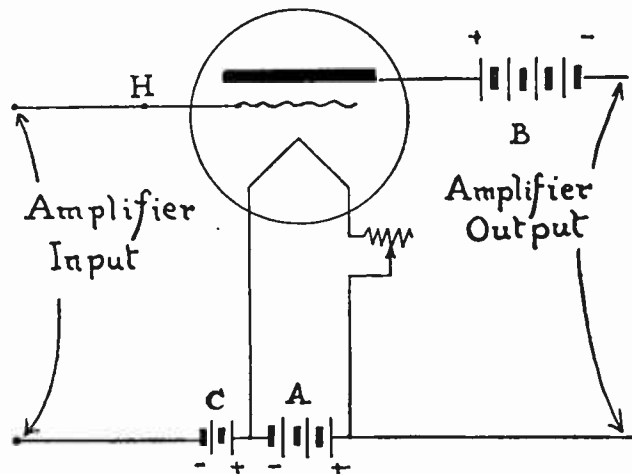

FIG. 5

The value of the negative potential applied to the grid may be varied by manipulation of the number of cells in the C battery in this circuit. The connection between the A and C batteries should be as short as possible. The rheostat, in this instance, is in the positive lead of the A battery

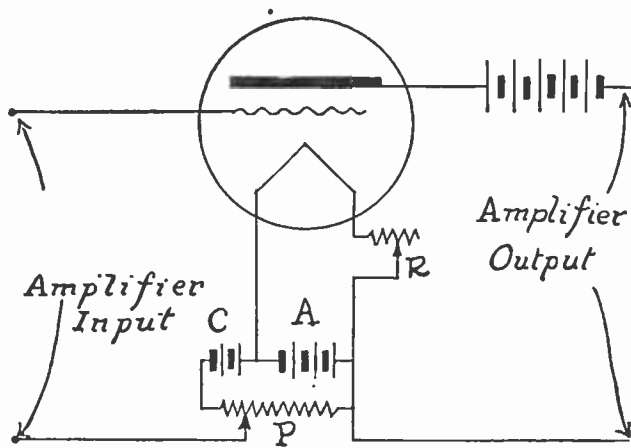

FIG. 6

The best arrangement for amplifier tubes is shown here. By means of the 400-ohm potentiometer it is possible to procure the best value of grid voltage for the operation of the particular tube you are using

operation, so that the optimum point of operation may be readily secured. A potentiometer of comparatively high resistance must be used for this purpose, as otherwise the loss, due to the steady current sent through it by the A and C batteries, which are in series, may become expensive and objectionable.

The A battery may consist of dry cells, in the case where WD-11 or UV-201-A tubes are used, but it will probably be a storage battery, since several or either of these tubes may be operated in parallel. The C battery can be made up best of ordinary dry cells, since flashlight batteries will wear out very much sooner in circuits where a potentiometer is used, as in figure 6. For example, if the resistance of the potentiometer is 400 ohms, then for a 6-volt A battery and a 4-volt C battery, there will be 25 milliamperes flowing during the period when the tube is in operation.

Figure 7 illustrates the use of a soft detector tube in conjunction with two stages of audio-frequency amplification, in which UV-201-A tubes are used. The potentiometer P furnishes the necessary fine variation in plate voltage for the proper operation of the soft detector tube. The plate lead of the detector tube is connected to the primary of the first audio-frequency

transformer, and then to the 22½-volt tap on the B battery. The grids of the two amplifying tubes are given a negative bias of from -1 to -4.5 volts by means of the biasing battery shown. This particular battery may consist best of a flashlight type, for, as it carries almost no current, its life will be practically its "shelf life." The jacks enable the operator to utilize the detector tube alone, or the detector tube in conjunction with one or both of the stages of amplification. The plate potential of the two amplifier tubes varies from 60 to 80 volts. A potential of 60 volts will probably be ample, unless the receivers are replaced by a loud-speaking device. Beyond a certain point, there is little advantage in increasing the plate voltage. The biasing battery has a tendency to increase the intensity of the signals over certain ranges of frequency, but with ordinary amplifying transformers, the improvement, due to the insertion of the C battery, may produce comparative distortion, because it will tend to make the amplifier operate more powerfully for certain frequencies, and no better for others.

Figure 8 shows a similar circuit, to be used with three WD-11 tubes, the first tube acting as a detector. In this case, there is no potentiometer in the detector-tube circuit, since the detector-tube plate voltage is not critical. The grid bias is furnished by the necessary number of flashlight cells, inserted as shown by C in the figure. WD-11 tubes will work very well without any biasing battery, but under these

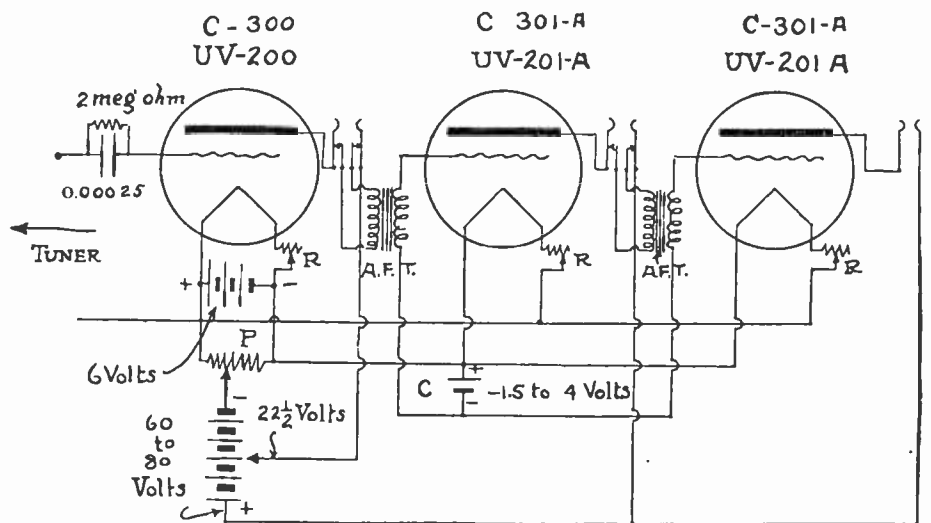

FIG. 7

This is a detector and two-stage audio amplifier circuit which may be made of standard parts and applied to any receiver. The detector tube should be soft, such as the C-300, UV-200, Moorehead, Audiotron, or De Forest type. Any hard tubes may be used in the amplifier circuit

conditions it would be better to put the filament rheostats in the negative filament leads of the two amplifying tubes shown. In the figure, the rheostats are placed in the positive filament leads of the two tubes, owing to the insertion of the "C," or biasing battery.

Where the battery arrangement shown in figure 7 is used in a radio-frequency amplifier circuit, the circuit will probably be subject to oscillation the moment the grid becomes the least bit negative, so that the C battery shown is hardly necessary.

Logically, it would be ideal to operate the tube with a negative grid potential, but in the case of most radio-frequency amplifiers, the grid must be made slightly positive in order to introduce a loss, which will keep the circuit from oscillating. Any mechanical or electrical system will vibrate if it is once excited, as long as the resistance, or the friction in the circuit, is below a certain value. However, if the resistance is increased, then the system will cease to oscillate. This is evident, for example, in the case of the pendulum of a clock. If the pendulum of a clock is once pulled aside, it will oscillate for some time, even though the clock may not be wound. If the clock is wound, the spring furnishes energy to the pendulum as fast as it is lost to the friction, so that the pendulum continues to oscillate. However, if the pendulum were immersed in some very viscous liquid, then, even

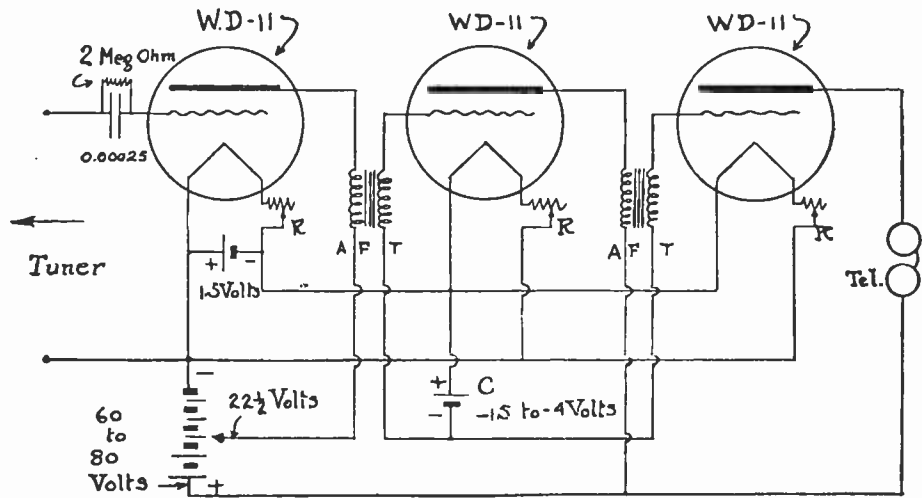

FIG. 8

Three WD-11 tubes are used in this circuit. If the C battery is not employed, it is better to place the filament rheostats for the two amplifier tubes in the negative lead of the A battery, instead of the positive as shown here

though it were given an impulse, it would not oscillate at all.

A C battery in the ordinary radio-frequency circuit is of no use, for the losses just mentioned must be introduced in order to keep the circuit from sliding. In the case of audio-frequency amplification, the results will be very disappointing if the grid is connected to the positive side of the A battery, but very satisfactory if the grid is given a negative bias of the proper amount.

The various arrangements shown illustrate the possible interconnections of the A and B batteries, and from an inspection of them, it should be clear that most circuits, as popularly shown, have been arranged subject to statements made in advanced treatments of vacuum tubes, in which the standard circuit shown in Fig. 1 is used as a standard basis for comparison only.

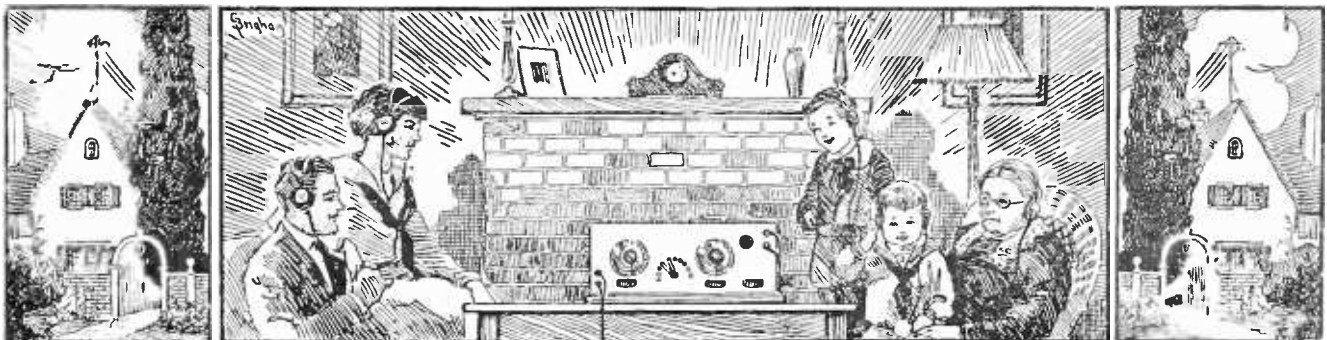

# A Man Who Built A Set He Has Never Seen

By ALFRED M. CADDELL

ONE sunshiny day in September, 1899, a police officer patrolling the streets in the Harlem district of New York heard the cry "Help! Help!" coming from a tenement house. Rushing into the darkened hallway, he hurried up the stairs. Suddenly a shot rang out, followed by another shot—and then the whole world became dark to him.

The officer was taken to the Harlem hospital. The best doctors in the city were rushed to his side. One of the bullets had entered his chest; but the other had penetrated his eyes and wrought such havoc that both of them had to be removed, depriving him of his sight forever.

That was almost a quarter century ago and during all the intervening years the likeness of no new object has come into this ex-policeman's life. But since that day he has done some remarkable things, not the least of which has been to construct a radio receiving set totally unassisted by any one except his twelve-year-old boy who read aloud various radio items and plans culled from newspapers and magazines!

Patrick O'Keefe was born in the Harlem district forty-eight years ago. He received his education in the public schools—that is, up to the age of eleven—and then started out to make his own living. Telegraphy sent out a call to him, and soon he became very proficient in the Morse code. He acquired a typewriter and

learned to write via the system of "hunt and peck." But presently telegraphy lost its charm as a vocation for a young man of such powerful physique. He was very active. He must be out of doors, and so on the 24th day of October, 1896, he became a member of New York's guardian police force.

Little could Officer O'Keefe realize, when he plunged into that dark tenement hall to investigate the cause of the disturbance, that those few moments would mark the passing of his sight. And throughout the following twenty-four years, or until the broadcasting wave swept over the land, little did he dream that he would travel to foreign shores and enjoy the scenery—via radio.

The other evening I called upon him in his Harlem home and heard his story. And he told it in a way that only a man who had actually lived through the privations of the blind could possibly have told it. Not a man given to self-pity and complaint—on the contrary, as thoroughly buoyant in spirits and health as people with the sense of sight, perhaps more so. A man of the world, with a strong grasp of the hand and a strong grasp on the affairs of the world. For as he sat and talked, and laughed and smoked, one could not help seeing that he had a feel on nature's finer things.

"Nature," he said, "has some wonderful compensating laws. When a man's sense of sight is taken away, the remaining senses come

Radio can and should be a permanent and increasing blessing to those who cannot see. It is the one best way in which the blind can lose the sense of remoteness from the lives of other people, and can enjoy the manifold activities which engage a busy world.

No doubt the manual skill and the power of visualization possessed by Mr. O'Keefe are qualities not found in all blind people. But whether they make their own sets or not, they should be introduced to the advantages that radio can bring them. As Mr. O'Keefe says, "Let the blind be thankful that radio is at hand—and also, *let them use it.*"

Those who can afford their own apparatus will find their investments a thousand times repaid; and as for those who cannot, especially those who spend their lives in institutions for the blind, we can only hope that the more fortunate and wealthy will appreciate the unparalleled opportunity they have for doing good.—THE EDITOR.

to the rescue, and become ever so much more acute. And, too, the loss of sight stimulates caution, easiness, patience—never a loss without some gain. Instead of the eye observing a panorama of things, a man's reason becomes better developed, and his nervous energy greatly conserved. Of course, the loss of sight is a great handicap, but I soon became accustomed to it. It wasn't long before I was taking long hikes to Westchester, wrestling with the boys, swimming, fishing, and otherwise enjoying myself in the sunshine and air. Several years after this handicap came upon me, I married, and my wife and children became the joy of my life.

"When did you become interested in radio?" the writer asked.

"Just about a year ago. Contrary to the custom of many blind folks who become more or less clannish and stay by themselves, I have always mingled with people who read the topics of the day. Or sometimes friends drop in with a few cigars and try to tease me. 'What kind of a cigar is this?' they will ask, just to see if I can tell by the aroma. Or else they will drop in to tell me what is going on at the club. On one of these occasions a friend told me about the development of radio, and related some of the wonderful things that could be taken out of the air—concerts, lectures, travel talks, stories, baseball scores, and code. And then my boy read from the newspapers what was going on in that line. I didn't know very much about how the thing worked, but the thought of listening to good music and the possible educational value of the lectures proved entirely too much for me, and I determined to find out something about this thing and to build myself a set.

"In my early days I had studied telegraphy and of course became familiar with batteries,



OPERATING THE SET HE MADE HIMSELF

Mr. O'Keefe, lost his sight twenty-four years ago. "No one knows the amount of good I get out of this little set," he says, "and no one can know but myself, for it is like an emotion—very hard to explain"

circuits and that sort of thing. And I understood a good deal about the telephone. So it came down to the point of cost and actual construction. Naturally, in my circumstances I had to confine myself to a crystal set, and I like the crystal very much. My boy read to me how to make the primary and secondary coils, how to mount the slide tuner, how to connect the crystal, coil, condenser, and phones in the circuit, and gradually I began to visualize in my mind just how the thing could be done.

"Visualization is half the battle. Also I began to comprehend inductance and capacity and to see why different taps had to be taken from the secondary in order to tune in on different wavelengths. And then came the condenser, detector, phones, and aerial—all this I got firmly in my mind and then proceeded to make a loose-coupler type of set.

"I had been handy with tools all my life, and had always derived a great deal of pleasure with a jack-knife. In fact, one of the first things I made after I lost my sight was a wooden chain which I had whittled out of a stick, and the keeper of the hotel where I was staying up in the Catskills liked it so much that he had it gilded and hung on the wall—not because of the beauty of the thing, perhaps, but because a blind man had made it. That called for visualizing a chain, and very careful carving in order to avoid spoiling the links. Then again some of the neighbors have brought in their clocks for me to fix, and other similar jobs, so all in all I have kept in pretty good trim. And with it I developed a sense of proportion and design, and as I set about the task of building my radio set I could see it being developed step by step—see it almost as well as a man with eyes.

"Dimensions of course were the principal thing. The secondary had to fit into the primary. I had to make calculations for the end boards, the stand it was to rest on, wire the coils, bolt on my condenser, the detector, insert my posts, connect to the aerial and so on. The set you see here is a loose-coupler type crystal set with a 43-plate condenser shunted across the secondary. It was the first set I built, but since then I have built three others—one for a girl across the street and two others for boys. I enjoy it immensely—there is nothing like being employed, no matter whether you are blind or not. It saves people from brooding and pitying themselves—self-pity is the worst affliction that can befall a man. What I have done, others can do, and they will be all the better for it, and if you publish this interview I hope it will reach the ears of blind folks so that they may learn of the advantages of radio.

"First, in the actual construction of my set, I started with the base board, visualizing where the coils ought to be, the condenser, the detector and where the lead-in and ground posts should be. I sawed this board from the solid end of a box, using a square to get the saw started straight, and applying it frequently to the board to learn if I was making a good job. Then for legs for the set I got hold of four base-board bumpers that folks sometime screw onto a door near the bottom to prevent the knob bruising the wall paper and plaster. Besides being about the right height—three inches or so

—they have rubber tips and come so nicely carved all ready to screw on that one wouldn't want anything better for legs. Then I sandpapered them and set about building my coils.

"That is where one of the things belonging to my wife came in—the much abused rolling pin. Besides proving wonderful kitchen night-sticks and pie-crust rollers, they are ideal for the winding of a coil—at least, it was so with me. My boy got a soap box for me and I cut out a small section on both sides, about two inches deep, to form sockets for the ends of the rolling pin to fit in. In a way, this acted as an improvised lathe. Then I ran the rolling pin through the cardboard cylinder on which was to be wound the coil. This proved a very good fit, and when the pin was set in the niches of the box I could turn it very steadily and evenly with one hand and guide the wire with the



other, and thus I wound my primary coil. The secondary of course was a little harder proposition because I had to jab holes through the cardboard with a hat pin every ten loops and lead the wire ends through, for taps to the switch points.

"The end board itself was a little difficult to make because I did not have an auger large enough to bore a  $3\frac{1}{2}$ -inch hole. But my youngster had one of those model building sets with which you can build towers and bridges and things. In this set were several small pieces of steel with a number of perforated holes half an inch apart. Taking two pieces of steel, I set an old Gillette safety-razor blade between them and bolted the steel and blade together. Little axles and collars also come with a building set, so I screwed a collar to the board, saw that my safety-razor blade was  $1\frac{3}{4}$  inches away, or half the diameter of the hole, and then swung it round and round like a compass knife, cutting deeper and deeper each time until finally I had cut all the way through the board. Right here, however, comes a joke on me—after I had spent the best part of a day making that  $3\frac{1}{2}$ -inch hole, I found out I could have bought an end board with a hole already in it for five cents! But I had the fun of figuring out a device for making it, anyway.

"The next step was to mount the condenser. This called for holes to be drilled in order to bolt the blade part to the meter scale. Drilling holes straight was a little difficult, but I managed to do it with the aid of a cardboard pat-

tern and a good deal of patience. The holes had to be straight in order to make the two parts jibe, and I certainly wanted the set to look as though a workman had constructed it, and if it looks the way I have visualized it, it must be O. K.

"Finding a sensitive spot on the crystal also proved a tedious proposition. Finally I got it with the aid of a buzzer, which also lets me know whether my tuner is in contact with the coil or not. Funny thing about these crystals. They seem very temperamental and shy. You never know where a sensitive spot might be, and after you get it you never know the reason why. I remember working practically the whole of one evening trying to find a sensitive spot on my crystal and was about to give it up and go to bed when a sudden little jar with my knee found the sensitive spot for me. I had the phones on my ears, and right away got the surprise of my life. I was tuned in at 360 meters and the first thing I heard was the name 'Patrick' coming over in code. Patrick is my name, but why it should be the first thing to come through or who sent it I do not know. Anyway, Patrick had found the sensitive spot on the crystal, and Patrick sat up until way long into the night listening to one of the best concerts he had ever heard."

Thereupon Mr. O'Keefe went on to tell of his experience with aerials. His first aerial was a wire that he ran out on the pulleys of the family clothes line. This proved rather weak. Then he tried running a wire around the house, and on the roof of the house, but it was dangerous for him to walk around an unguarded roof. Finally, he came to the use of a device which he screws into an electric light socket, the wiring circuit of the house acting as the aerial. This system has given excellent results, and inasmuch as he uses a condenser which is shunted across the secondary, and also a phone condenser, he is able to tune quite sharply. Altogether, his is one of the best arranged home-made crystal sets that the writer has ever seen, neatly constructed and yet as simple as can be.

"Painting was the only part of the work I didn't do myself," he said. "I wanted the set to look O. K., and while I could gather how it looked by the feel, I could not paint that way—that is, I didn't want to be putting my fingers on the painted surface to guide me in the work, so my boy painted it for me."

"What was the total cost of the set?" I asked.

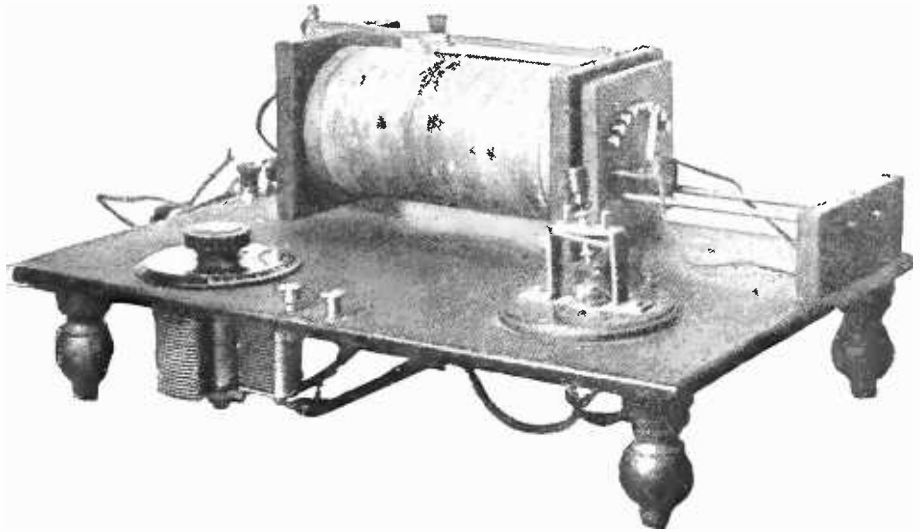

THE CRYSTAL SET WHICH MR. O'KEEFE MADE BUT HAS NEVER SEEN

It is almost inconceivable that a man who is totally blind can build a complete radio set unassisted, including winding the coils, and doing all the wood working. The secondary was wound over a rolling-pin; the legs of the platform are door-stops. Mr. O'Keefe cut the  $3\frac{1}{2}$ " hole in the loose-coupler end-piece with an improvised device employing a safety razor blade

"A little less than \$5.00," was the reply. "The condenser was the most expensive part of it, but it is worth all it cost as it helps me to tune out a station I don't happen to want. The phones are only a makeshift, but I make them do. The whole outfit gives very good satisfaction, and of course I get more than an ordinary amount of pleasure out of it on account of having made it myself."

The ex-policeman leaned back in his chair and puffed contentedly at a cigar. He was sitting in his "corner," or as his wife terms it, his "workshop." Directly overhead were his police department certificates. On one side of the chair, next to the mantel of the fireplace, stood a little table covered with tools, wire, and other odds and ends, and attached to this table was a swinging board supporting his present set. It is always within reach, and pretty nearly always in use. For wherever broadcasting is taking place in the metropolitan area here is one man quite willing to listen.

Next to his chair stood a little stool on which were several magazines for the blind, printed in

Braille, or the raised-dot system, various combinations of dots representing different letters in the alphabet. But I learned from Mr. O'Keefe that there is nothing in the literature for the blind pertaining to radio. He said this was most unfortunate, for of all people in the world who stand to benefit from radio the blind would probably head the list.

"I do not like to ask my wife and children to sit down and read to me," he explained. "The wife has her family work to do and the children have to prepare their school lessons, and it would be selfish on my part to take up much of their time. No, I enjoy sitting here a couple of hours at a time listening to what's going on in the world. No one knows the amount of good I get out of this little set, and no one can know but myself, for it is like an emotion—very hard to explain. I am a great lover of music, and certainly get the concerts very clear—that is, unless some fellow with a tube set allows it to oscillate and send out a flock of 'birdies.' But that doesn't happen very often, for I tune pretty sharply, and generally succeed in tuning them out. Music has a wonderful effect on me—simply lifts me right out of everything, and before radio came in I used to make a lot of it myself.

"The trips you can take via radio are certainly great. A short time ago the advertising manager of the American Express Company gave a series of travel talks on tours in foreign lands—and I went with him. I could visualize the foreign peoples he described, their ways of living, and every bit of the wonderful scenery. The Company never knew how much I enjoyed that trip! I have gone completely around the world, and it didn't cost me a cent. And then I went down to the dock on the East River and talked with an old salt who has been in every port in the world, one of those fellows who can describe things beautifully, and he went more into detail about the different places. But wasn't he surprised when I began to tell him all about Australia? He wondered how the deuce I knew!

"But the best sport of all comes from people who don't know they are broadcasting. For instance, at some of these banquets, the speeches are picked up by microphone and re-

layed to a station to be broadcasted. Now the average man doesn't know how sensitive a microphone is, and unwittingly two or three fellows sitting near the microphone will discuss the ladies and drop whispers to one another in a confidential tone. And away, perhaps for thousands of miles, those little confidences will be wafted by the radio waves to fall on listening ears.

"At one of these formal gatherings the toastmaster announced that Charles M. Schwab would speak. Mr. Schwab gave a very fine address, and during the course of it he commenced to laugh. That laugh tickled me, and I remembered it. One evening I heard the same laugh again, and I said to my wife, 'My friend Charlie Schwab is here,' and sure enough he was afterward introduced to speak. He had evidently been sitting near the microphone, unaware that people with phones over their ears were enjoying the merrymaking too.

"The world's series, the big football games, the horse races—all the sports come to me through the air. Last summer, a friend of mine dropped in and I began telling him all about the ball game. 'How did you hear about it?' he asked. He had been to the game that very afternoon himself, and had got soaking wet in the rain, whereas I sat here perfectly contented and heard Grantland Rice say 'Now the pitcher is winding up, and now he lets it go.' And I didn't get wet, either.

"Of course, my machine is limited to a radius of about 25 miles—the more powerful sets bring in the far-away station, but I get as much as I want at that. Next summer a friend and I are going fishing along the North Shore, and I am certainly going to take my little set along and rig up an aerial on the boat.

Yes, indeed, radio is a wonderful boon to humanity, and I look forward to still greater things. Somehow I think that an artificial sense of sight could be stimulated in people who have lost the sight of their eyes. I haven't any worth-while suggestions to offer, but perhaps someone who knows more about radio than I do will discover a method. In the meantime, let the blind be thankful that radio is at hand—and, also, let them use it."





# A Loop Receiver in the Tropics

By CHARLES T. WHITEFIELD

I WONDER if many fans have had the fun from a receiver which has been given us by our loop machine. We found it a not considerable package to carry with us on the steamer from New York, and forthwith set it up on deck and attended New York concerts and church services on Sunday to the enjoyment of the passengers.

The apparatus failed us in only one particular. When we moved it to the salon, which is well below decks, it refused to speak—doubtless too much steel between it and the outer world.

From Nassau, in the British West Indies, we get everything 2,000 miles and less north, south, east, and west during the evening, and find it most difficult to get good signals in the daytime; but at night the concerts and lectures come most clearly and the news we pick up from WOO, Philadelphia, is a godsend when news is scarce and from three days to a week late.

Perhaps our most amusing experience was to take the machine to one of the "Out Islands," so called, where wireless was never heard of and the natives were skeptical and superstitious. When we asked them if they would like to go to a church service held in New York, they showed small interest in such "foolish talk"; but when the voice of the minister was heard and the hymns sung by the congregation they thought the end of the world was upon them. They did not at first enjoy the exper-

ience—looked for telegraph wires, and finally gave up in despair as to how the trick was done.

But in the Bahamas, as elsewhere, radio is making its way. A year ago there was not a listening-in amateur in these islands. This year there are well on to six or eight, and the art is spreading. People away from the centres where batteries and parts are sold have no easy time of it. In all the islands you cannot

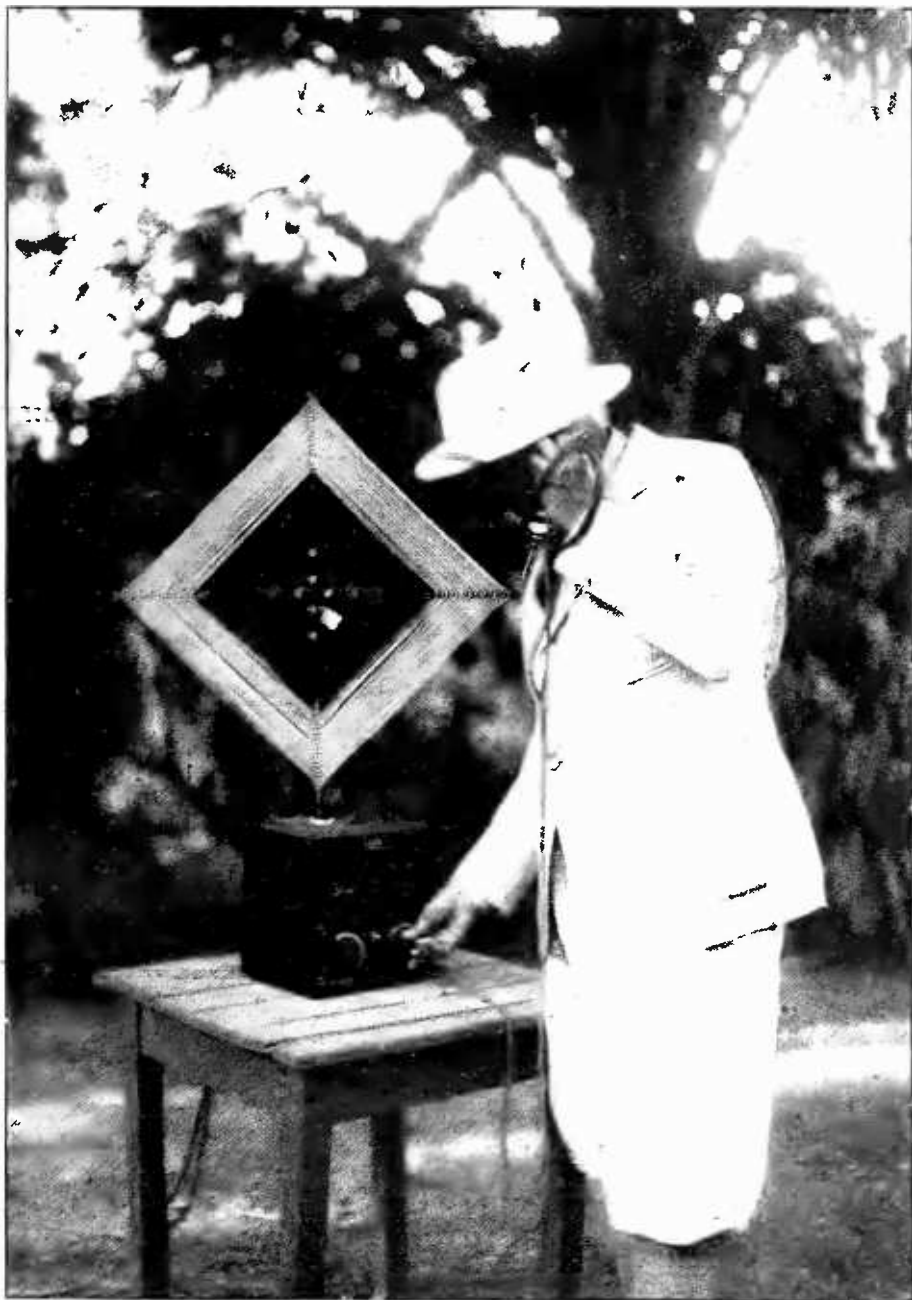

OPERATING THE LOOP RECEIVER IN NASSAU, B. W. I.

buy a tube, a battery, or a head set, or, indeed, any essential part of a radio machine beyond wire, and sets part at a premium. But that condition is changing rapidly because of the great opportunities to hear the outer world perform in a manner which has never been heard of before.

Common report has it—and it is no doubt true—that the Bahamas are the very home of static, and most amateurs shut up shop in April and do not expect to listen in again until November.

I have found the loop aerial much more successful in resisting static than outside aerials. As a matter of fact, so far, to April 1st, it has bothered us not "too much," as the natives say. The one thing that puts us completely out of business is the wireless station on the hill at Nassau. When it starts in to tick off messages to Miami 180 miles away at over 30 cents a word it settles down and drowns us out like flashes of lightning, and we must shut up our telephone headpieces until the messages are complete.

As in England and all British Colonies one can not possess and operate a receiving instrument without a license, and a license is a serious matter. You must apply in writing, and the

matter is then taken up "on behalf of the Governor in Council," and after two weeks or so, if you appear to be a reliable person in good standing, you receive an involved document of three pages. With the license comes a bill for five shillings for a year's use of the machine, and you are at liberty to proceed.

When we set up our machine there was some question about the risk of stringing wires because of lightning, etc. When it was found out that our set required no wires and gave no sign outside of the house, "The Governor in Council" was perplexed, this being the first loop set ever set up in the Islands.

One's pleasure is often heightened when clear and loud signals come in from northern cities that they are suffering from a blizzard and the performers had difficulty in getting to the station because of the storm, while we sit here in our lightest clothes, with windows and doors open to catch the evening breeze. But we hear, too, from the South. A few nights ago we searched about for the news bulletin and, failing, got Porto Rico, and were informed to our great delight that world news would be distributed. We listened with all our ears, only to hear it all in Spanish, of which not a soul in the room understood a word.

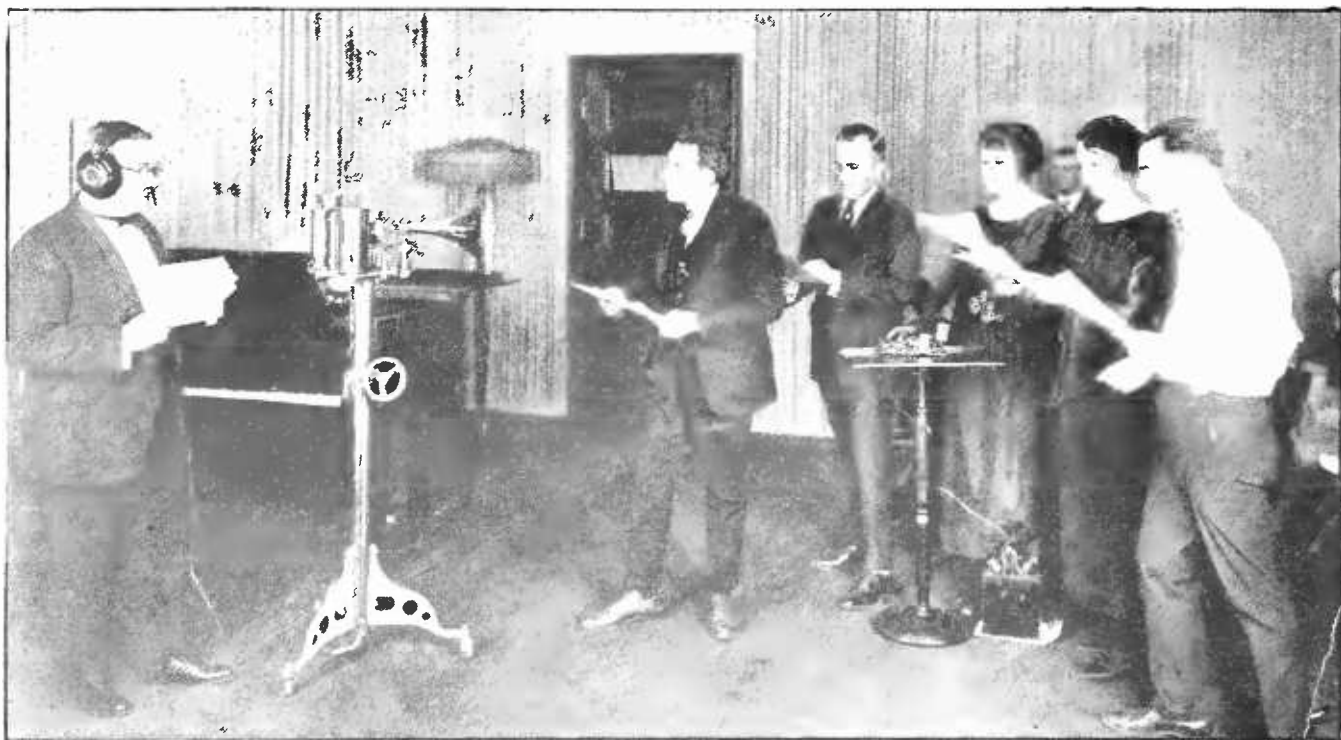

PUTTING "THE TRAVELING SALESMAN" ON THE AIR AT WGY, SCHENECTADY

The scene is laid in a small railroad station—hence the telegraph instrument. The director's phones, padded to exclude all local sounds, are connected to a set outside which is tuned to the concert. By holding up printed cards, he can inform the players how they are "registering"

# With the Broadcasters



## GRAIN PRICES GOING OUT

This ticker at WLAG reports the prices of cash grain and grain for future delivery from the Exchange Room of the Minneapolis Chamber of Commerce



## EDITH BENNETT

Who sang to Europe from WOR, the Bamberger store at Newark, N. J. She is considered by many as the finest radio singer



## THE "HIRED HAND"

Announcing at WBAP, the *Star-Telegram* station at Fort Worth, Texas. He is president of the Radio Truth Society, with a membership of 10,000 fans



## GANNA WALSKA

Grand Opera singer, the wife of Harold McCormick, broadcasting from the Waldorf Astoria studio of WJZ, in New York City

# Protecting Your Invention

First Aid for Those Struck by Patentable Ideas

By ROGER SHERMAN HOAR

Former Assistant Attorney General of Massachusetts

**N**O ONE will deny that "'tis better to be safe than sorry." Suppose that you have an original idea, as some day you may. You do not think that it amounts to much, you have no intention of ever patenting it, you are even reasonably sure that it isn't patentable; and yet it may eventually turn out to be very valuable. Why not play safe and protect your invention from the very start? The fact that you are the original and first inventor will avail you nothing unless you preserve the evidence to prove this fact, and even then you may not be safe unless you take certain further steps.

Therefore, the moment you conceive of a new and useful invention, you should at once prepare an "evidence of conception": i.e., a sketch, signed by the inventor, recording the date of conception, and witnessed by two persons, whose endorsement should read substantially as follows: "(date) Explained to and understood by (signatures)."

Such a sketch should contain, or be accompanied by, a sufficient written description to render the drawing perfectly clear and understandable.

This paper serves several purposes. First, it provides you with two witnesses who can prove your date of conception and date of first disclosure. Then too, it constitutes your first drawing and first written description. Thus you have, in a single document, the means of answering the first four questions which will arise in any interference proceeding, and of proving your answer.

There are many persons who will solemnly inform you that an evidence of conception is invalid unless it is written in ink, signed by two witnesses and acknowledged before a notary. What do they mean, invalid? An evidence of conception is not a Patent-Office form! Furthermore, it has no foundation either in rule or in statute.

The only function of an evidence of conception is to refresh the recollection of one (or both) of the witnesses, so that he can testify

to the dates of conception, drawing, description and disclosure, if necessary, and can make that testimony sound a little more plausible than merely his own uncorroborated word.

If it accomplishes this end, the most informal paper, written in pencil, and signed by a single witness, is sufficient. Even a single witness, without any paper, will do, if he has a good memory and tells a convincing story. But, believe me, his story has got to be convincing! Over three hundred witnesses, produced by Drawbaugh to prove that he invented the telephone before Bell, failed to convince the U. S. Supreme Court, because not one of the witnesses had had the device *explained* to him by Drawbaugh.

So, as a practical matter, rather than as a legal requirement, the more formalities that you can add, within reason, the safer you will be. But note those two words: "within reason." Too much formality is apt to defeat itself by suggesting to the Court that it has been faked to bolster up a weak case. But by far the worst objection is that the greater the formality of a form, the less often will an inventor take the bother to use it. And the evidence of conception should certainly be frequently used.

Among the refinements sometimes employed is the following. The inventor places the paper in an envelope, has the notary seal it, sends it to himself by registered mail, and then doesn't open the envelope until, if ever, it is presented in court.

It is important not only to prepare an evidence of conception, but to prepare it at the earliest possible date. Don't wait for the complete idea to develop, but draw up a paper the moment you have the first hazy outline of your invention. Draw up other papers from time to time, as you work out your details. The most valuable part of your patent will be its broad general claims, and these will be adequately supported by your first general idea.

Your next consideration should be to use due diligence in "reduction to practice," i. e.,

in either building an actual operative machine, or (what is equally effective) filing a patent application. This latter is called "constructive" reduction to practice. Under certain circumstances two months' delay has been held lack of diligence; and eight years has been held diligence; so you see how little the time element has to do with the question.

If you apply for a patent, a diligent reduction to practice is sufficient to entitle you to claim your original conception date. But, if you do *not* apply for a patent, you will have to rely on your first bona fide sale, public use or publication. A fake sale won't do. Hence the importance of selling, using or publishing as early as possible. But this has the disadvantage of starting the running of the two-year period, after which your right to apply for a patent is automatically forfeited. And in the case of publication, there is the additional danger of having your write-up construed as a dedication of your invention to the public. So be sure and include in your write-up a statement that you intend to apply for a patent.

On the whole, therefore, it is much wiser to apply for a patent, even for the mere purpose of retaining your own right to make your own invention. But if you are sure that you do not want a patent, you can effectively play the dog in the manger by publishing a full account of your invention in some magazine. This will render void any patent thereafter conceived; and after two years will render void any patent application thereafter filed, even if conceived prior to your publication.

Beware of permitting the general use of your device prior to your applying for a patent, for this is likely to be construed as a complete abandonment of your invention.

If you decide to apply for a patent, the first

point for you to settle in your own mind is just why you have so decided. Is it because of the fundamental value of the patented novelty; or as a mere scare-crow to keep others from duplicating some distinctive but not particularly patentable feature? Is it to protect yourself in manufacturing your own device? Is it as a mere feeler, to save the expense of an attorney's search of the prior art; or to drag others into an interference, and thus ascertain what are the latest developments along certain lines? Is it to sell the patent, or to secure royalties? Or

is it for some other reason? On an intelligent analysis of these questions, at the outset, will depend the handling of the case to the best advantage.

Very often, if your chief desire is merely to keep some one from making a "Chinese copy" of your machine, you can secure a "design patent" on its artistic appearance, even though the machine itself possesses no patentable novelty. But the Patent Office is particularly on its guard against this subterfuge.

If you decide to apply for a patent, you or your attorney must prepare a drawing, a petition, a specification, some claims, and

an oath. These must be gotten up in exact accordance with the "Rules of Practice," a booklet distributed free by the Patent Office. It would pay every inventor to have a copy of this booklet, and to study it frequently. As to whether or not to have a lawyer, and what kind of a lawyer to get, see next month's article.

The Patent Office has some very technical compulsory regulations with regard to drawings, which regulations can be found in the "Rules of Practice." Special printed bristol-board blanks can be purchased through almost any stationer. But what always mystified me about these blanks was: why do they say "INVENTOR" and "ATTORNEYS," when in my

### Patent, Patent, Who's Got the Patent?

It's a great game, according to Mr. Hoar, but you must know how to play it. Many apparently queer tricks are practised for perfectly sound reasons.

Do you know:

Why "most patent lawyers intentionally make several serious misprints in the application?"

Under what conditions an inventor will address and mail a letter to himself?

When it is advisable to make your claims broad, and when narrow?

How to "smoke out a lot of prior art?"

How to avoid "the danger of having your write-up construed as a dedication of your invention to the public?"

This is the third article in a series of four dealing with patents in a clear and practical manner. The other articles are "What Good Is a Patent?" in the April number; "What Can Be Patented?," last month; and "Miscellaneous Considerations," to appear in RADIO BROADCAST for July.—THE EDITOR.

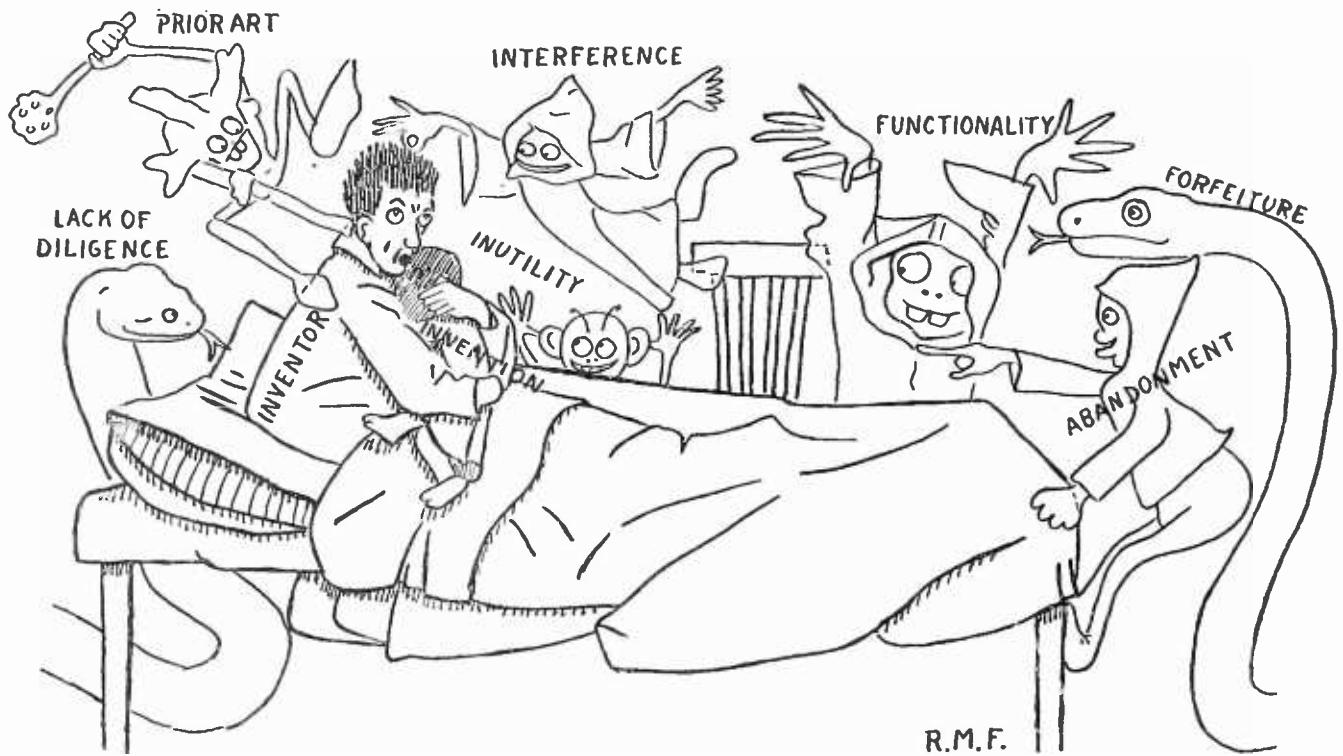

"SEEIN' THINGS AT NIGHT"

experience there is usually more than one inventor, and only one attorney?

The petition is a brief formal request for a patent; and, if the applicant has a lawyer, contains his power of attorney, in which case a twenty-five-cent revenue stamp must be affixed.

The specification usually contains a statement of what a hopeless state the art was in before you came along and saved the day with your epoch-making idea, a summary of the principal objects of your invention, an explanation of your drawing, a description of how your device works, and some general language claiming that your invention is not limited to the specific form disclosed by you, but rather is applicable to almost anything under the sun.

The claims are detailed statements of every possible combination of the new ideas involved in your invention. For examples of specifications and claims, study some recent patent obtained by some large corporation, active in the radio patent field.

Ought you to draw the claims broad or narrow? Broad claims are useful to smoke out a lot of prior art, and thus show the inventor exactly where he stands. Also to drag more pending cases into interference, and thus advise you as to what others are doing in the same field. Also to bring into the record some prior patent, which you are afraid that you infringe. This last is often a very important consideration.

You will see, later in this article, that one of the three ways of avoiding a patent cited by the examiner, is to prove that your invention does not infringe it. Your argument is entirely one-sided, as the owner of the earlier patent is not given a chance to present his case. Thus you may be able to get a Patent Office ruling to the effect that you do not infringe this patent, and this ruling will have great weight in your favor, if you are ever called into an actual infringement suit. The advantages of trying your case first in the Patent Office are obvious.

Entirely apart from the above special reasons for making your claims broad, there is the general reason that you naturally wish to get as broad a patent as possible.

But, if you are well acquainted with the prior art, and so realize just how far you can go with valid claims, it may be desirable to draw your claims narrow, for purposes of speed and a clear record. The advantages of a clear record are twofold. First, any infringer of your patent will, of course, try to prove that it is invalid, and his first step will be to secure from Washington the "file wrapper" of your case, i.e. the complete record of office actions and amendments. The less that there is in your file wrapper, the less starting point has your enemy. Secondly, a patent with a clear file wrapper is much more readily salable to the

average manufacturer, due to his ignorance of patent law; although personally I should prefer the very fullest record, as this would show that we were getting the broadest possible patent, and also that there was less chance of some prior art, overlooked by the examiner, cropping up later in the courts.

Even when you can secure broad claims, it is essential that your patent should also contain narrow claims, running all the way down to claims covering every nut, bolt and screw in the utmost detail. The reason for this is that if your patent ever gets into litigation, some of your broadest claims are certain to go by the board, and you should be prepared to contest the ground foot by foot as you retreat. Thus the succession of gradually narrowing claims exists for much the same reason as the succession of first-, second-, and third-line trenches in war.

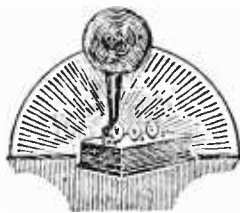

Be sure that you have enough claims to cover adequately every phase of your invention, but beware of having too many claims. "Multiplicity of claims," as it is called, will irritate and antagonize the examiner, and if your patent ever gets into court, will cause the judge to interpret it most narrowly. But a basic patent, or one which represents a long forward step, is entitled to many more claims than a patent which covers merely some minor improvement.

Usually the claims of a patent application are rather tentatively drawn at first, in order to sound out the patent examiner and see what prior art he can discover. After the Patent Office has passed on it, your attorney will be in a position to redraw the claims, in view of the prior patents which the examiner has produced. Therefore, it would be most unfortunate to have an application allowed right off the bat. To guard against this, by insuring the receipt of at least one adverse office action, most patent lawyers intentionally make several serious misprints in the application.

A patent application, broadly speaking, consists in: (1) a complete disclosure of the invention, so that those skilled in the particular art will be able to duplicate it; and (2) claims as to what part of the disclosure the inventor wishes protected by the patent.

The oath asserts that you are the original and first inventor, and denies that the device was known, used, published or patented prior to your conception, or used or on sale in the

United States more than two years prior to your application, or patented abroad more than one year prior to your application.

The drawing is signed by the attorney. The petition and claims are signed by you. The oath is signed and sworn to by you. The filing fee is twenty dollars.

At any time from three to fifteen months (according to how far behind in its work is the division of the Patent Office to which your case happens to be assigned) you will receive an "office action" pointing out the misprints in your papers, and disallowing some of your claims for lack of utility, or for incompleteness, or for not being supported by the disclosure in your drawing and specifications, or for being "functional" (i.e. attempting to cover the need, or result or effect of

your device), or for not being an improvement over the "prior art," in which latter case certain earlier patents will be cited against you. The examiner may require you to divide your application, on the ground that it contains matters which should be handled by two separate branches of the Office. In rare cases, some of your claims may be allowed.

Within one year of the action, you must "amend," i.e., file a paper correcting the mistakes, and either changing your drawing, specification and claims to meet the objections of the examiner, or else arguing with him in an attempt to convince him that he is wrong.

There are three ways of getting around a citation: (1) amend your claim; (2) convince the examiner that the cited patent has no bearing on your invention; or (3) convince him that your invention is an improvement over the other.

If you get away with No. 2, you are clear of the other patent. If you get away with No. 3, your claim will be allowed, but will infringe the other patent, if it is still alive.

But note that, although the *claims* of an earlier patent are all that is material to the question of *infringement*, yet either the drawing, specification, or claims of that patent may decide the question of *anticipation*: i.e., whether the other fellow beat you to it.

I find that there is a persistent idea among technical men that, in order to get around a prior patent which is cited against you by the Patent Office, it is necessary to file some sort of paper agreeing to hold your patent subject to this prior patent, and that this is the signifi-

icance of the references to earlier patents, frequently found in printed specifications. But nothing could be further from the truth. This mention is usually either for the purpose of shortening your description, by referring the reader to some earlier step in the development of the art; or for the purpose of giving to a divisional application the benefit of the filing date of the parent case.

An application becomes abandoned, if the applicant fails to reply within one year after any office action; or becomes forfeited, if he fails to pay the final fee within six months after allowance. If not prevented by some other consideration, a new application can be filed in place of an abandoned one; and, if filed before abandonment is complete, can rely on the filing date of the original. A forfeited application can be renewed within two years after allowance.

Division of an application is affected by striking out the objected claims, and then embodying them in a new application.

If either the specification or claims of one application covers the same invention contained in either the specification or claims of another application, the Patent Office may ask either party to adopt certain claims of the other by amendment, and may then declare an interference, throw open the files of each party to the other, and require evidence as to which party is the first inventor. But before doing this, the Patent Office frequently requests of the junior party an informal statement as to the date of his conception, and if this date is not earlier than the filing-date of the senior party, no interference is declared.

The first step in an interference is the preliminary statement, the contents of which, and the relative value thereof, we discussed last month. If the preliminary statements do not prove sufficient, further evidence may be filed in their support, but no inventor will be allowed to claim any dates earlier than those of his statement, except for extraordinary reasons. The disputed claims are allowed to the party who proves first invention coupled with diligence in reduction to practice.

An interference is sometimes declared between a pending application and a patent issued not more than two years before the application was filed. The grounds are slightly different in this case, for only the *claims* of the

issued patent are considered. But, as a victory for the applicant will not result in cancelling the prior patent, and as the whole matter will have to be fought all over in the courts, it may be well for the applicant to avoid interference, and insist upon the issuance of his own patent, on *ex parte* proof that his conception was earlier than the other's filing date.

In handling a patent case, an almost unlimited amount of delay is possible. Thus you can wait nearly a year after each office action before amending; and, in order to guard against premature allowance of your application, you can keep making intentional mistakes in every amendment. But note that an amendment which does not represent a bona fide attempt to meet the action of the examiner, or which merely reiterates an argument once rejected by the examiner, will not prevent the case from becoming abandoned through one year's failure to respond to an office action.

The chief object of delay is to extend the date to which your patent will protect you: i.e., seventeen years from the date of issuance. The later your patent issues, the longer it will protect you. Thus, in the absence of other considerations, a reputable attorney will always delay as much as possible.

On the other hand, extreme speed may be desirable to secure immediate protection against infringement, or to put the patent in shape for a speedy sale or as the basis for foreign applications. You see, a foreign application should be filed within a year of your American application, and should be drawn in the light of all the information which you can possibly glean from the Patent Office as to the state of the prior art. Hence the rush.

But inventors are apt to be influenced by a very natural curiosity to learn as soon as possible how their case is going to turn out. And lawyers without an extensive clientèle are apt to be influenced by a very natural desire to get their pay as soon as possible. Both of these tendencies should be guarded against.

If the examiner twice rejects a claim on the same grounds, the applicant can appeal to the examiners in chief by paying a \$10 fee. From them, a \$20 appeal lies to the Commissioner of Patents; and from him a \$15 appeal to the Court of Appeals of the District of Columbia. Printed records and arguments must usually be furnished on appeal.





Beware of "double patenting"! Two patents cannot be obtained by the same person for the same invention, nor can a broader and more basic patent be obtained by the holder of a more detailed or more advanced patent. In either such case, if the second patent inadvertently issues, it will be void. So it is imperative to draw your first application so as to cover everything that you will ever wish covered. Also you should be careful not to let some subsidiary later application issue before your basic one, although there are some court decisions which hold that this is allowable.

The rule against double patenting has even been extended, so that if two inventors in the same field assign their applications to the same assignee, and if a patent issues on the narrower and latest-filed application, then this patent will prevent the issuing of a patent on the broader application, although first filed. This is based upon the fact that two applications, owned by a common assignee, cannot be put into interference with each other, and upon the theory that the choice by the owner to let one of these patents issue first, is equivalent to an adjudication of priority in favor of the inventor of that patent.

When, by numerous amendments, your case has at last been put in condition for allowance, the final fee of \$20 must be paid within six months. Thereupon, on the fourth Tuesday after the Thursday after your fee was received, the patent will issue and will be published in the next *Official Gazette*.

An issued patent, from which has been inadvertently omitted some important claim covered by the disclosure, or whose disclosure

is insufficient to support its claims, may be surrendered at any time within two years of issue, and a petition for a "reissue" be filed, on which the procedure will be very similar to the procedure on an original application.

If an issued patent claims more than the inventor is entitled to, he can file a "disclaimer" of the excess. Personally, I never could see any particular point to disclaimers. True, if you sue a man for infringement, and he can show that your patent was too broad, then the judge will not award you your costs. But, even so, since the chief value of a patent is as a scare-crow, I should prefer to have my patents as broad as possible, and take a chance on losing my costs.

In the foregoing article we have covered not only Patent-Office procedure, but also some phases of Patent-Office tactics, which most inventors think should be left strictly to their attorney. Most attorneys think this too. But, don't you believe it! Unless the inventor thoroughly understands the tactics of his case, he will not be able to decide intelligently the questions which his attorney puts up to him, and may unjustly blame his attorney for carelessness, delay, etc., when these may happen to be exactly what the situation demands.

Napoleon once said that he owed his success to his knowledge of *tic tacs*. When asked if he did not mean "tactics," he said: "No". He ascribed his skill in getting out of difficulties to his practice of putting tick-tacks on the teachers' windows and then not getting caught. So, if some of the foregoing article savors more of tick-tacks than of tactics, I hope that the reader will excuse me.



---

### Wanted—Information on Railroad Radio

The Committee on Application of Radio to Moving Trains of the Association of Railway Electrical Engineers desires to communicate with any one who can give information regarding actual experiments in radio reception or transmission to or from a moving train.

Kindly communicate with the Chairman of the Committee,

Mr. P. S. Westcott,  
Assistant Car-Lighting Engineer,  
Chicago, Milwaukee & St. Paul Ry. Company,  
West Milwaukee Shops, Milwaukee, Wisconsin

# The Search for a Telephone as Sensitive as the Ear

By GEORGE B. CROUSE

Chief Engineer of the Connecticut Instrument Co.

**T**HE most important instrument in radio broadcast systems is older than the pyramids, as old as the race itself. This instrument is the human ear. To say that the ear is of first importance is not an exaggeration, for to you no improvement in a radio device would be of the slightest use or interest, were you not equipped with ears. It is of first importance to the engineer, because he can neither redesign it nor improve it; he must take it as he finds it, study its characteristics, and build all the rest of his apparatus to fit its needs.

Even aside from the interest which this organ holds for us as designers and users of radio, the marvelous ingenuity and delicacy of its construction, its accuracy and the wide range of its functions, make it one of the most fascinating organisms in nature. This article, therefore, has for its purpose the explanation of the construction of the ear and the discussion of some of the problems which its characteristics have placed before the designers of radio telephone systems.

Considering the functions which our auditory apparatus performs for us, it first of all detects the presence of sound vibrations in the air. Second, it determines the relative loudness of various sounds and to some extent the actual loudness of a single sound; we say sounds are loud or soft. Third, the ear distinguishes various kinds and qualities of sounds; it distinguishes and identifies the barking of a dog, the rattle of a carriage wheel on the street, the voices of our friends: the trained ear will distinguish the difference between two violins when played successively by the same man in the same way. Fourth, our two ears acting together detect roughly the direction from which a sound is proceeding, but since this is a function which is not of much interest to us in radio, we will not consider the mechanics of its performance.

Turning now to the devices which perform for us these functions, we will undertake the explanation by designing a model to perform in

a manner similar to the ear. In this model we shall combine elements and apparatus ordinarily used in radio telephones.

Historically, it is undoubtedly true that in the lower forms of life the auditory apparatus performs only two functions, those of detecting and roughly measuring the loudness of a sound. We are, therefore, justified in dividing our explanation in two parts and considering first only these two functions.

An apparatus for these purposes would logically take the form shown in Fig. 1 where we have a horn (1) to gather up and concentrate the sound waves at its small end, where they cause a diaphragm (2) to vibrate. On the centre of this diaphragm is placed a carbon microphone (3). This is the device ordinarily used in telephone transmitters and its function is to vary its resistance in unison with vibrations applied to it. We connect this microphone in circuit with a dry battery (4) and the primary winding (5) of a transformer. This transformer may be an audio-frequency transformer taken from a radio set. Now when the current in this primary winding varies, due to the variation in resistance of the microphone, it causes a proportional alternating current to flow in the secondary winding (6) and we measure this alternating current with the meter (7). Then we have a complete instrument for detecting the presence of a sound falling on the diaphragm and for measuring its loudness on the scale of the meter.

This sounds simple enough until we remember that for this apparatus to be the equal of the human ear, it must be capable of detecting a motion of the air of one thousandth of a millionth of an inch, while at the other extreme, it must not be overloaded by air motions ten thousand times as great.

In order to perform the third function of analysing and determining the character of a sound, our model will become much more complex and its explanation requires a short digression to consider the character of sound waves.

You remember in your class-room days, that

in the physics course, the principle of resonance was demonstrated by setting up a tuning fork (Fig. 2) which was not vibrating and bringing near it a second identical fork which was sounding. After a while the fork which originally was not vibrating was found to be in motion. This motion was set up by the energy of the sound waves proceeding from the second fork. If the two forks were not exactly alike, the motion would not be transferred from one to the other. The principle is the same as when a church bell or an old-fashioned swing is set in motion by applying small impulses at exactly the right time.

Now to set a tuning fork in vibration by means of sound waves falling on it, the sound must have exactly the same pitch as the pitch of the fork, but this sound need not be generated by another tuning fork. It may come from a piano string, the human voice, a pipe organ, or any other source. However, if we use say a piano string to set the fork vibrating, it will be found that the sound will set forks of several different pitches vibrating. On the other hand, if our source of sound is an open diapason organ pipe, only one size fork will be found to move. This is due to the fact that the sound of a piano is "compound" or made up of a number of simple sounds, whereas the sound of the open diapason organ pipes is pure. Practically all sounds are compound and their

number of them would be required. If while a sound acts on these forks, we observe which of them have been set in vibration and to what extent, we have an accurate knowledge of the character of the sound.

Now the ear employs just this principle. It contains a series of bodies which like the tuning forks are capable of vibrating at one pitch and one pitch only. The incoming sound acts on these bodies and sets the proper ones in vibration and the nerve terminals determine the amount of the motion.

Before we proceed to build this principle into our model, however, we must examine the properties of the ear a little more closely. When one actually tries the experiment with the tuning forks it is apparent that a certain length of time is required to set the fork in vibration by resonance and that the motion when once set up persists for some time after the cessation of the sound which caused it. Now we know that in the ear, the response and analysis is almost instantaneous and that a sound ceases to be heard very quickly after the sound itself has ceased. If this were not so we would be totally unable to follow a fast conversation or a rapidly executed piece of music: the syllables and notes would run into each other and become confused.

For this reason we must find some way of causing the sound to affect the forks quickly

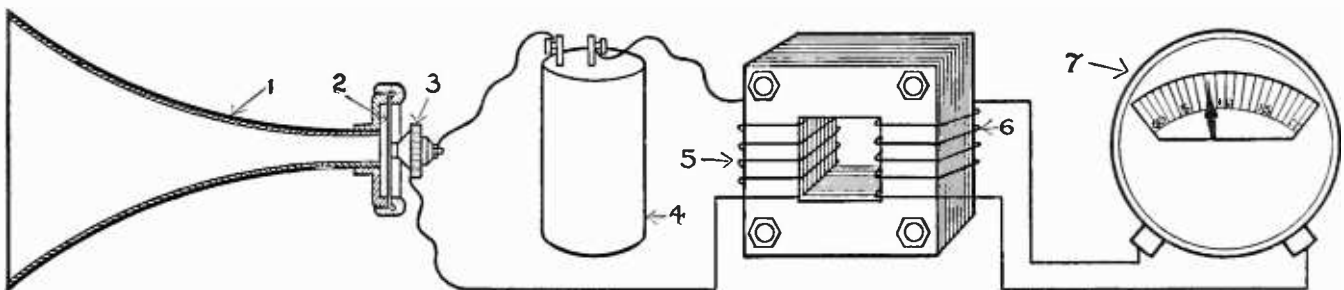

FIG. 1

Apparatus for detecting and roughly measuring the loudness of a sound

character is determined by the number and relative loudness of the various simple sounds which they contain.

Therefore, if we wish to determine the character of a sound we have to analyze it and determine the pitch and relative loudness of the various simple sounds which it may contain. For this purpose, we might use a battery of tuning forks, upon which the sound to be analyzed is allowed to fall. Each of these forks would differ from the other in pitch and a great num-

and of quickly stopping their motion after the sound has ceased. The way in which this is accomplished in the human ear and the best way for us to accomplish it in our model, is to immerse the forks in liquid instead of air. The greater weight of the liquid will be more effective in moving the forks and the viscosity of the liquid will be effective in stopping or "damping" their motion after the sound has ceased.

Our complete apparatus will then take the form shown in Fig. 3 where as before we have a

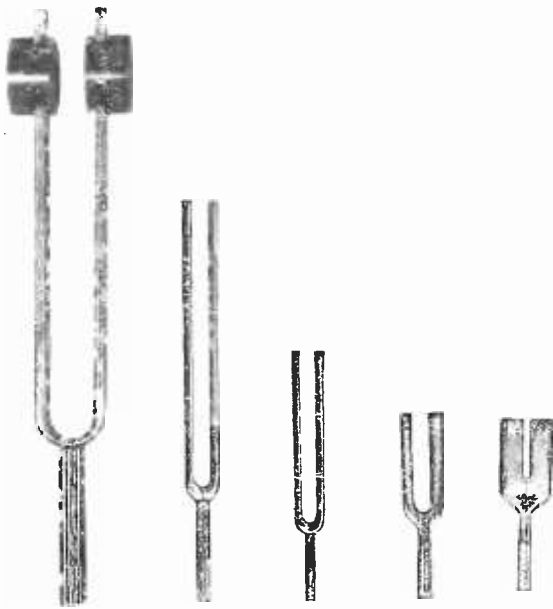

FIG. 2

The vibrations of one tuning-fork will not cause a second fork to vibrate, and thus produce a musical sound, unless both have the same vibration rate. However, the sounds produced by a piano string, the human voice, or a pipe organ, for example, may cause vibrations in more than one of the forks, since such sounds are made up of many simple tones, some of them being the same as those of the tuning-forks

horn (1) which gathers up and concentrates the sound waves at the small end, where they cause the diaphragm (2) to vibrate in unison. The motion of this diaphragm will then have to be transferred to a liquid and since the liquid will be very much heavier and harder to move than the air, we must employ a leverage between the diaphragm and the liquid. This leverage we have shown as a simple lever (3) attached at one end to the diaphragm (2), pivoted at the point (4), and attached at the other end to a second diaphragm (5) which encloses the liquid in the chamber (6). Since liquids are practically incompressible, we must employ a third diaphragm (7) at the other end of the chamber so that the liquid can move freely. In the liquid chamber (6) we place a large number of tuning forks, each of a different pitch and attach to each of these forks a carbon microphone (8-8 etc.), each with its electrical connections to a battery, transformer and meter.

Then the sound entering the large end of the horn is concentrated at the small end and causes the diaphragm (2) to vibrate. The motion is then transferred by the lever (3) to the second diaphragm (5) and thence to the liquid in the chamber (6). Movement of the liquid causes

the forks corresponding to the various simple components of the sound to vibrate in proportion to the strength of the components. This motion of the forks affects the attached microphones and thus indicates on the meters (9-9, etc.) We thus have a complete apparatus for detecting the presence of a sound, determining its loudness and analyzing it into its components and thus determining its character. We have shown only five forks in the model but it must be understood that it would be necessary to have many thousands of them. The lowest fork would have a pitch corresponding to about 32 vibrations per second and the highest from 30,000 to 40,000 per second.

The human ear is constructed in principle almost exactly like our model as will be seen from Fig. 4. In this figure we have the external ear (1) corresponding to the horn for gathering up the sound and concentrating it on the diaphragm or drumskin (2). The leverage between the drumskin and the second diaphragm in the liquid chamber is obtained by a system of three bones (3) named from their appearance, the hammer, the anvil and the stirrup. This particular form of lever is employed to prevent any unusual shock from injuring the delicate apparatus of the inner ear, since these bones are arranged so that they slip over each other at their joints if too great a motion is imparted to them. The liquid chamber is shown at (6). It consists of a bony case shaped like a snail shell and named from its appearance the Cochlea. The end of the lever system is attached to the second diaphragm known as the Oval Window (4). The third diaphragm for the purpose of allowing freedom of motion of the liquid shown at (5) is known as the Round Window. In the liquid chamber or Cochlea (6) are located the thousands of vibrating bodies of various shapes and sizes which take the place of the tuning forks in our model. The microphones of the model are replaced by nerve terminals attached to each of the vibrating bodies, each terminal being connected to the brain or measuring instrument by its own nerve fibre.

This short description cannot do justice to the wonderful refinement and ingenuity displayed in the design of our ears, and the action of some of the mechanism is still imperfectly understood. We know very little about the construction of the vibrating bodies, particularly those which are employed to respond to the lowest frequencies. These vibrators are so

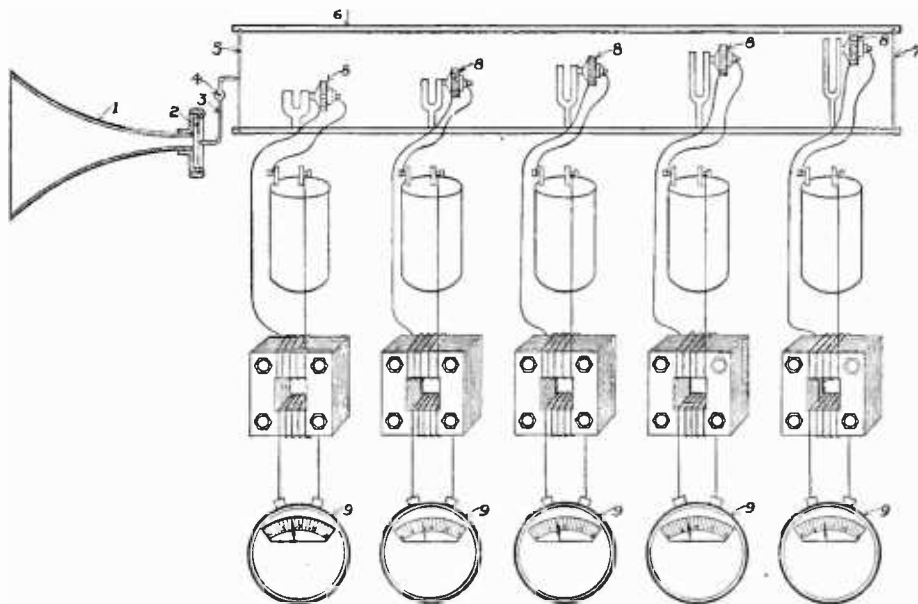

FIG. 3

Vibrations are readily started and quickly "damped" when the tuning-forks are immersed in liquid. This indicates an apparatus for detecting the presence of a sound, and determining its loudness and character. The human ear is constructed in principle in a similar way

small that they are not visible to the naked eye, as indeed they must be to be crowded into the small space available. That they do vibrate at one pitch and at one pitch only we know. Neither have we the space to describe the apparatus for equalizing the pressure on both sides of the drumskin, nor the means for tuning the drum, nor a host of other devices which go to make up the complete organism.

This description is sufficient, however, for us to gain a clear idea of the capabilities and limitations of the ear which must be taken into account in the design of radio and acoustical apparatus.

The most significant factor in the construction of the ear is the completeness of the analyzing apparatus. We should expect that the question of distortion in radio telephones would be a very serious one, for the ear is not easily fooled. This subject of distortion has been completely covered in a previous article\* in which we pointed out most of the things which a radio telephone must do to please the ear. We shall, therefore, confine

\*"How Your Telephones Work," RADIO BROADCAST for January, 1923.

ourselves here to those things which the system must *not* do.

From this point of view, the extreme small size of the parts of the ear is significant as will be seen from Fig. 4 and as though Nature had not gone far enough in this direction to astonish us, she tucked into the corners the apparatus by which we balance ourselves on two feet. The smallness of the fibre which connect the vibrators with the brain is even more extraordinary. Some idea of their size may be gained from the fact that the entire cable, containing thousands of nerves, is less than  $\frac{1}{10}$  inch in diameter.

From this we are at once led to suspect that one of the weak points in the design of the ear is liability to fatigue and particularly to fatigue from the sounding of a single note. The case is very much as though, in our model, we made the wires connecting the microphones with the measuring instruments very small so that if they were used very long at a time they would heat and increase their resistance. In the case of the auditory nerves exactly this happens, with the additional psychological factor that when a nerve is fatigued, we become nervous and exasperated.

This point is readily proved from your own experience. Almost everybody has at some time in his or her life been irritated to the point of exasperation by children's voices and this

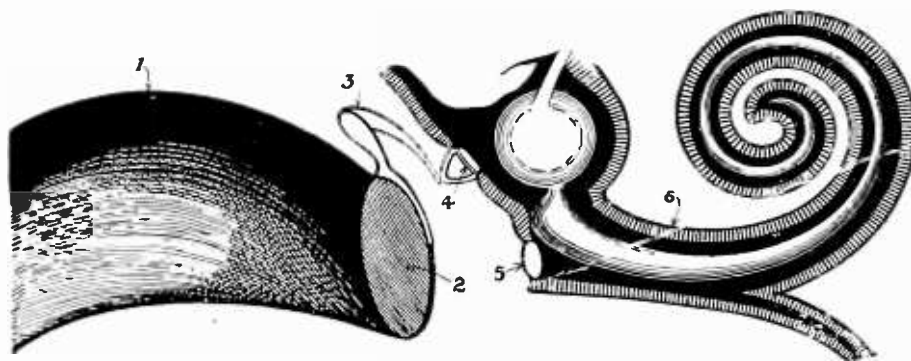

FIG. 4

The mechanism of the human ear. (1) External ear; (2) drumskin; (3) leverage apparatus: "hammer," "anvil," and "stirrup"; (4) Oval Window; (5) Round Window; (6) Cochlea

does not arise from any lack of sympathy with children. It is due to the fact that children have not yet learned the knack of tonal modulation, so that they talk at almost a constant pitch and this is more particularly true when they are excited or interested in their play. The result is that the voice sounds have all to reach the brain of the listener over a very small number of nerve fibres which soon become exhausted.

It is true that not all monotonous sounds are irritating, but the reasons for this lie in the brain rather than in the ear. The brain has the power under certain circumstances to shut off most of the current to a given set of nerve fibres, so that they are not fatigued although excited for long periods. This control exists, however, only when the sound which is shut off is different in character or pitch from the sounds to which we are trained to direct attention. For instance, we can easily shut out the noise of the wheels on the rails when riding in a railway carriage. On the other hand we are trained from infancy to pay attention to the sound of human voices and therefore we find it most difficult to shut out the annoying voices of children at play.

It is also very difficult for the brain to shut out sounds that are similar to other sounds which it wishes to hear. Have you ever watched a piano tuner search all over the room for the object which insists on vibrating in resonance with a certain string on the piano? The reason is that he wishes to listen to the sounds of the piano and he, therefore, finds it impossible to shut out the other similar sound.

A further simple experiment to prove this point is to have someone play any selection on the piano and while this is in progress tap a single key of the piano lightly and continuously. It will be impossible to direct the attention away from this insistent note and it will generally be found that the result is so annoying to everyone within hearing that the experimenter will be forced to discontinue his work "under pressure of public opinion."

A long series of tests and experiments along the above line, some of them simple, others of a more technical nature, have convinced the writer and his associates that this liability to local fatigue is one of the most important characteristics of the ear from the viewpoint of the designer of acoustical apparatus. This con-

clusion has a particularly important bearing on the design of the acoustical elements of a radio telephone system. On the ordinary telephone, we never listen for very long at a time, even though it may seem an eternity when waiting to use a party line, whereas in radio broadcasting we may listen continuously for hours. For an illustration of the way in which this knowledge of the characteristics of the ear should be applied in the radio art, we turn naturally to our own products, telephone receivers and loud speakers, since we speak there with the greatest authority. When radio broad-

casting first came into popularity, the only telephone units available for its reception were those which had been used for land line telephone and wireless telegraphy. Now practically all of these telephones employed a magnetic system which varied the pull on an iron diaphragm in accordance with the incoming signal. We

tested a great number of diaphragms of iron and other metals and found that all of them had very definite natural periods. In other words, they could be and were forced by the magnetic system to vibrate at the proper pitches. However, when so vibrating, they also vibrated at their own natural pitch which never changed. Here we have the ideal condition for fatigue of the ear.

The problem was then to devise a telephone diaphragm which was "dead", or in other words, which would not vibrate freely by itself. This problem was not an easy one, for it was found very early that all of the metallic materials had strong natural periods which could not be completely killed without greatly reducing the sensitivity of the phone. However, after experimenting with a great variety of substances, a non-metallic diaphragm material was found which satisfied the requirements. Receivers constructed of this material have no single-pitch clamor. A large number of them have been placed in use and where we have been able to obtain the opinions of the users, they are unanimous that these instruments may be used continuously without annoyance. Results in actual service by a large number of users are the final check of any theory. We believe, therefore, that we have proved the importance of the study of the ear and have justified the statement that the ear is the most important of radio instruments.



# Concerts for All in a Veterans' Hospital

By J. TOWNSEND BRADLEY

WHO would have thought that the very operators that pounded the keys off Belle Island north to the White Sea, during the War, would be some day turning on a set as easily as a phonograph and getting the best of music and entertainment, leaning back in an easy chair and just listening, without the dreaded "Dangerous Area" reports or without fear of missing his call? What the few lines that follow have to do with, is the percentage of Navy and Army men that didn't quite get through and who have been in Government Hospitals for the last few years. To be specific, this article concerns the U. S. Veterans Hospital No. 50, which along with its Commanding Officer, is well known and a favorite indeed with the Veterans.

The majority of the men here at Prescott, Arizona, do not know much about radio, but there are about forty loyal radio fans and among them a liberal sprinkling of Army and Navy operators. The entire group are ardent fans and aside from the study they are making of radio, they furnish quite a lot of amusement to their bunkies. Nearly every ward has a radio set and in some wards two may be found. The result is that the heretofore long evenings are now passed enjoyably with the programs of KHJ, KF1, and KPO as well as many other stations.

The receivers used vary from a small one-tube set to the elaborate five-tube variety. The majority are home-made, but quite a number of the men prefer to buy them ready made. The general practice here is to use head phones because loud speakers require quite a volume to operate satisfactorily and then are likely to wake up some patient, which means in many instances that his whole night's sleep is disturbed. The ear phones are generally connected to a double lamp cord that runs along the moulding and down to the receiver. Thus in case a patient does not care to leave his bed and go down to his buddy's radio, all he has to do is to lean over and put his phones on, and in comes the music.

Wards 2, 10, 11 and 14 are so connected. The Ward 14 radio set is the largest, using a Kennedy Type 101 receiver with a Type 525 Audio Amplifier and a Wireless Specialty Shop two-stage radio-frequency attachment. The antenna and ground are brought to one plug which can be used in such a way as to use the radio-frequency amplifiers or not. The same connection is used for the loop, which has a small variable condenser to tune it, in addition to the regular clips.

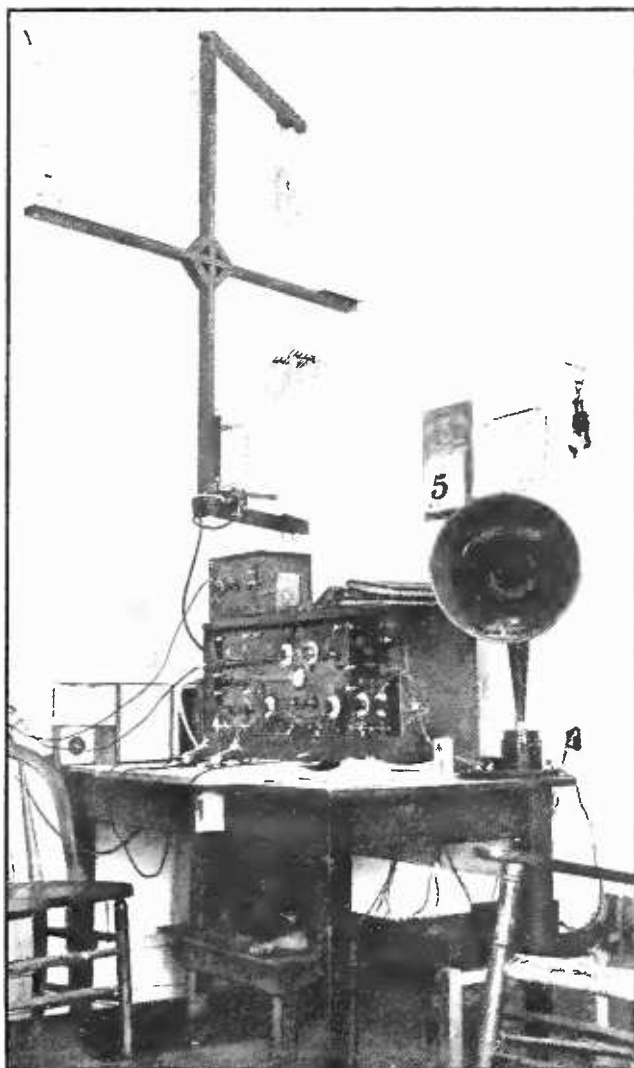

THE 5-TUBE RECEIVER IN WARD 14  
The veterans at the Prescott, Arizona, hospital enjoy concerts from stations 1500 miles away, using the loop antenna shown in the picture

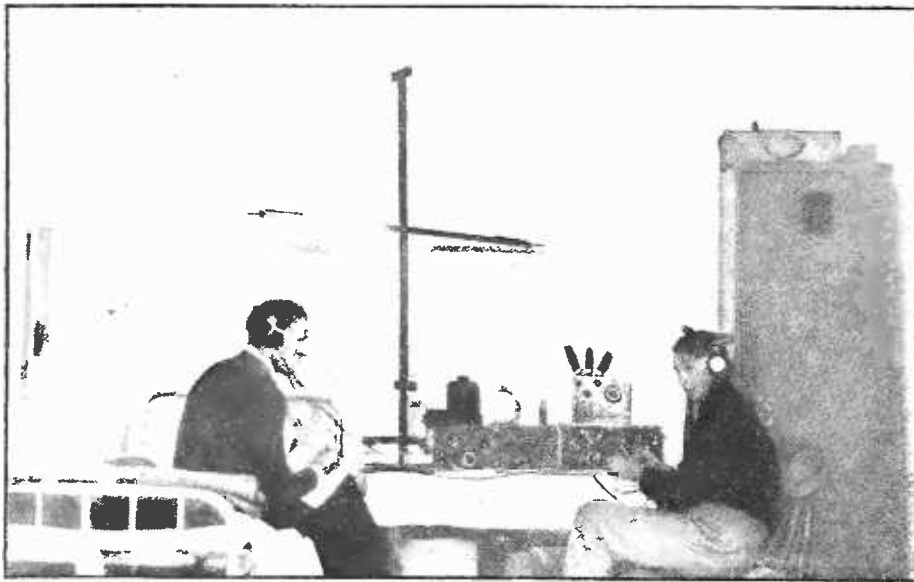

TUNING-IN WITH "HOME-MADE STUFF"

V. S. Keggs and G. B. Gilchrist listening to a station on the west coast. Head phones are generally used in the wards so that the sets may be operated without disturbing one's neighbors, especially during the evening hours

Those of you who have not worked with radio in this part of the country do not know what we have to contend with. The power lines cause a great deal of interference and reception is usually done only during the night. The big set will bring in the signals fairly well, especially on cloudy or rainy days. We always can get arc and spark and as several of the men are ex-Army and Navy operators, they copy it down for practice. If it's press, it is hung up for everyone to see.

On nights when the static comes roaring in we connect our loop and a few stages of radio-frequency, and manage to do remarkably good

work. The longest distance covered by the loop so far on telephone work is between one thousand to fifteen hundred miles. On the outdoor antenna we get both coasts, Canada and Mexico, while on arc and spark signals we tune in most anything.

than the one at Phoenix, Arizona, is about four hundred miles away, while San Francisco and Portland stations are at a much greater distance but still come in so loud that the windows quiver. Our favorite stations are KHJ, KFJ, KPO, and the Kansas City *Star's* Night Hawks.

The loud speaker, when connected and placed near a window, has been heard all over this end of the Post and when the wind is favorable, has been heard as far away as Ward 2, which is at least three quarters of a mile distant. You city people must remember that our nearest broadcasting station, other than the one at Phoenix, Arizona, is about four hundred miles away, while San Francisco and Portland stations are at a much greater distance but still come in so loud that the windows quiver. Our favorite stations are KHJ, KFJ, KPO, and the Kansas City *Star's* Night Hawks.

Aside from amusing the gang and their visitors, and members of the Staff at this hospital, the station is used to test out the home-made sets and to try out numerous ideas that some of the men have put into practice. The place is nearly always full of sets and parts to be tried out.

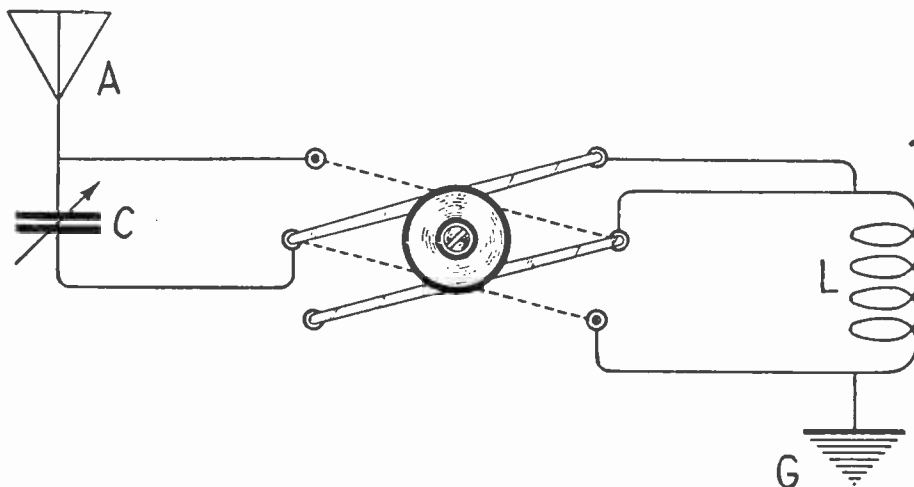

HERE'S AN IDEA

A Marion, Ohio, reader sends us the accompanying diagram with the remark: "Why use eight switch points with a series-parallel switch when six will do and simplify the wiring?"



# Adventures on an American Yacht in Mexico

A Few Intimate Glimpses of Actual Happenings in the Life of a Commerical Radio Operator. Here We Find the Reason for so Many Young Men Entering Radio as a Career

By A. HENRY

Going to sea is what radio operating usually means, and true stories of life, as an operator finds it, are usually a bit salty. The author of this article has operated afloat and ashore. He is, as we say in radio, an "old timer" and whether you sailed the seven seas when he did, or expect to sail, or are sailing, or never expect to leave your home town—life as it is lived aboard ship should be interesting to you.

This is the fourth of a series of true stories from the life of a commercial operator. Next month, Mr. Henry will tell about his trip around the West Indies on the Duke of Sutherland's yacht, the S. Y. *Cantania*.  
—THE EDITOR.

**A** LONG toward the middle of April I was standing with a group of operators in the "static room" at 29 Cliff Street, New York, swapping stories and waiting for something to happen. Now and again the buzzer up on the wall would bark out the signals that spelled an operator's name. He would enter the superintendent's holy of holies to be commended, transferred or fired, and then return to our group.

For some reason or other I hated that buzzer—it always filled me with unpleasant forebodings and each time it spoke, its menace was removed only when I recognized the first two or three letters of a name not my own. I had been in the static room for periods of an hour or two on the sailing and arrival days for three successive trips now, and I had not been called. Just as I was beginning to think that my fears were unfounded and feel almost as much

at home as some of the older members of the operating profession—the passengers and crew of a coastwise liner—when I heard my last name squawking from the buzzer and recognized the smooth swing of the "Super," who had formerly been an operator.

Before his desk I felt like a culprit for no other reason than foolish fear. There was nothing I could think of to be worried about

but I couldn't help feeling that there was something in the wind. Without so much as looking up he asked me if I knew how to install, operate and keep in repair a 2-KW synchronous transmitter and type E tuner. That took my breath away but I gaspingly said something about being able to do it if I could look one over for a few days. Although I had never actually seen one I had read up on it quite a

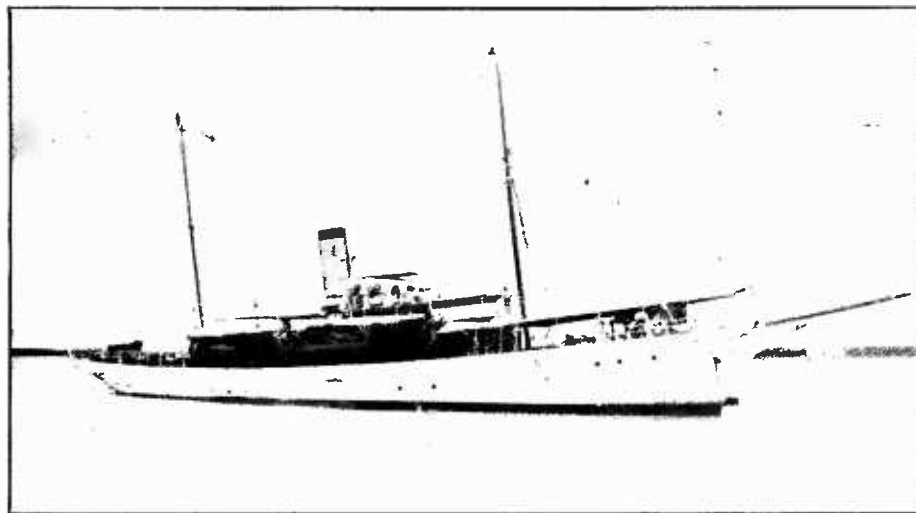

S. Y. "WAKIVA 1"

Anchored in the Panuco River, a few miles below Tampico. Steam was always up and the yacht kept in readiness to weigh anchor at a moment's notice

little and felt that it was but necessary to reduce my book knowledge to practice.

"All right," quoth this lord high executioner, "you have free rein in the school and in the repair department and a week to learn all you can. Then I'm going to send you out to do the job on a yacht and I feel that you will do it properly. Will you?"

As you may guess, I assured him that I

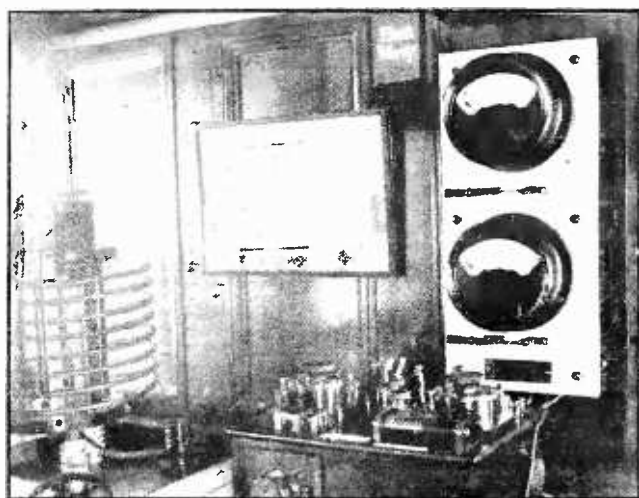

THE NEW RADIO ROOM WAS FINISHED AT LAST

And I transferred the 2 K. W. outfit to its new home. There was hardly room to get the camera in when the job was done

would. For the moment, I forgot that I had recently fallen in love with a young lady in Jacksonville and did not want to leave my present job, but there was no backing down and the mails would have to be relied upon temporarily.

So I spent a week in the school and managed to make a general nuisance of myself by asking the mechanics too many questions of a technical nature which they dodged by becoming angry. Upon the completion of my training I was presented with a wavemeter, which in those days was a rare instrument, and received an assignment as junior operator on a ship bound for Nassau and Tampico. The yacht to which I was assigned was in Tampico and the plan was for me to work my way down and for the operator there to work his way back.

After a voyage during which there was only one short period of excitement we arrived in Tampico. The excitement occurred some time between one and six one hot morning after we had rounded Tortugas and were in the Gulf of Mexico. The radio room was of more ample proportions than most and it was much easier to stand night watches in a steamer chair, one of which was easily obtained from the deck. On the particular night in question I had procured the chair and had made it more comfortable by the addition of a pillow from my bunk. I had locked the wooden screen of the radio shack on the inside, making it impossible for any one to get in the window. Then I closed the door and poked the front end of my chair against it to keep it closed as there was no lock. During the night I fell asleep and was

rather rudely awakened by having my chair pushed along the floor as someone opened the door. There was no getting out of it: the Captain himself caught me red-handed, asleep on watch. He delivered a lecture to which I listened very attentively—and when he departed my repose was continued.

In Tampico I was rather surprised to find that we were docked along a great wharf with several other vessels of goodly size. It was not my idea of Mexico at all. I had expected to find a few adobe huts and a group of Mexicans stealing each other's horses and scrapping over a beautiful señorita. Tampico, in many respects, looked like innumerable other small cities.

After several trips to and from the yacht, which was anchored some three miles down the river, my things were transferred and the other operator and I changed abodes. My new room was a dream. As there were no guests aboard, the officers were using the guests' quarters and my room, which adjoined the captain's, was a great deal more sumptuous than any of those I had occupied on previous assignments, and when I forgot about my huge salary of thirty-five dollars a month (I had been raised five, on accepting this foreign assignment) you may be sure I felt very much of a lord.

There was a complete crew aboard and I was surprised to learn that steam was always up and the yacht kept in readiness to weigh anchor and depart at a moment's notice.

Let me digress for a moment and tell you why the yacht was in Mexico. A certain oil company had holdings outside Tampico and maintained its offices in the city. At the time we are considering, just about ten years ago, there was quite a turmoil under way in dear old Mexico, and Americans were looked upon with anything but favor. American oil tank steamers, taking on cargoes at Tampico, could make it easy for those operating the loading station if they reported their approach by radio. This was particularly true in view of the unreliable operation of the telegraph lines. The Mexicans would not hear of the establishment of a radio station at the loading point so the yacht was sent down and anchored a few feet from shore. A telephone line was run out to her and the whole arrangement was at least as good as a land station would have been, from an operating standpoint.

In addition, two swift motor boats were provided to carry the employees from the city

to the yacht in case of emergency. For a time the emergency seemed imminent. The United States appreciated the situation as evidenced by the battleship *Connecticut* that rode at anchor off the bar just beyond the mouth of the Panuco River.

Part of my duty was the checking up of incoming oil steamers and advising the local agent, whose office was only a short distance from the point where we swung listlessly amid the muddy water that swished along our side as it passed out to sea. Time and again the American Consul at Tampico would call me on the phone and request me to relay a message to the *Connecticut*. Unfortunately, my end of the conversation could not be kept secret from some Mexican carpenters engaged in building a new radio cabin into which I was one day to transfer the installation. These gentlemen were of rebel tendencies and, though we never gave much attention to them, we wouldn't have trusted them with a plugged nickel.

Now and again "bum-boat" men would come down the river with the tide and offer us all manner of tropical delicacies such as mangoes, plantains, pineapples, alligator pears and limes. As a rule they were permitted aboard and their smiles and bows and "Si señor's" and "mañanas" all aided them in removing the shekels from our jeans without resistance. They were not the blood curdling variety of Mexicans at all.

Except for having to sleep under a mosquito bar to prevent being eaten alive, I was pretty well satisfied and managed to become very friendly with most of the crew. My association with one of the sailors and a mess-boy peevd the captain more than a little and soon won his whole-souled ill-favor. Among other things, he arranged to have me eat at the second sitting in the mess hall, which was for the quartermasters, cooks, second cooks, mess boys, etc. Of course I put up a howl but it availed me nothing.

In the meantime, I had become quite friendly with four English fellows who operated the radio outfits on English vessels plying

between Tampico and Galveston and Port Arthur. One of them agreed to purchase some itch powder for me; which he did. One day I was seated in my room with the door into the hallway wide open. The mess boy, with whom I had become friendly and for whose friendship I had suffered humiliation, was also the attendant who took care of the captain's room and my own. As I sat there drawing, he came in with my laundry and put it all away for me. The captain's bundle, he had dropped in the hallway as he came by. With a wink I asked him if he could not find something to occupy him on deck for a half hour. He agreed and departed. The captain's laundry was moved into my room and the door closed. It was then unpacked one piece at a time and given a treatment of itch powder and just as neatly repacked and replaced in the hallway. Need I describe the captain's misery for the next two weeks?

Inasmuch as it was necessary for a certain number of us to be on board at night, the liberty launch would take one bunch one night and another the next. As a rule I was satisfied to stay aboard but did like to take the ride up with the gang and come back to the yacht to copy press from Sayville or Key West or Arlington. Then I'd go back when the launch did and help round up the drunkards. Even the fellows who had no use for me when they were sober were quite friendly after a few shots of *cerveza*, the Mexican for beer, and they came down to the dock with me in fine style.

There is one such rounding up expedition that will linger long in my memory. The fellows



A FOURTH O' JULY LIBERTY PARTY

had been paid and were out to paint the town red. We pulled in as usual—the boatswain and I—at the little dock some two blocks from the plaza which was in the center of the town. Just one block from our dock was a ramshackle *cantina* for which the fellows steered when they began to think of returning home. Here we would round up most of them, put them in the launch and go back for the rest. They would content themselves in hilarious manner or in slumber according to their particular bent until we returned. As a rule the sober ones would join our scouting party. On the night I have in mind, we rounded up all but one and were about to return to the boat without him when, on a corner a block away, I heard him wrangling with a Mexican policeman. From the names the officer was being called I knew that our wandering boy had been indulging in stronger spirits than *cerveza*. I arrived, after a sprint, just in time to prevent the cop's lantern from being kicked across the street. The cop proved a decent sort and smiled as I persuaded the quartermaster to come along with me. By the time we had staggered to the *cantina* on the corner, the others had all returned to the launch and were shouting for us to hurry.

Now and then one of the partly sober fellows in the launch would address a yell to my charge which the latter would return in kind, accentuating the reply with a wild hat waving and gesticulation. He refused point-blank to pass

the *cantina* without “jush one lil drink, Shpark, jush one more lil drink.” So I let go of him and in he went, while I yelled to those in the launch to wait for us.

I went into the *cantina*. Two Mexicans were seated opposite each other at a small table, their sombrero rims touching each other and two glasses of some sort of liquor before them. They were evidently engrossed in the discussion of some weighty problem. Before I could get around the tables that intervened, the quartermaster had poked his face up between the two, knocking off their hats as he did so. He looked at one, then the other, reached for their glasses and turned them upside down on the table. I expected gun play, but there seemed to be no guns. Instead, there was one of those sudden tropical rains—of glassware. I slid into a corner and turned a table over on top of myself. The few minutes I was there seemed like a life-time and just as the free-for-all was about to end, the crowd from the launch, attracted by the row, put in their appearance, the half-drunken ones yelling like fiends. Again the fray was on. Then I heard wild blasts from a police whistle and four policemen raced in, lanterns and all. In a jiffy the lanterns had been whisked from them and were behaving like comets with a jag on as they were thrown back and forth. One of them exploded behind the bar and covered a Mexican with burning oil. In his fright he ran around like a wild man and finally went out with most of the others racing

after him. That ended the scrap. The heads in our party were bleeding as we made our way back to the yacht, arriving some three hours late.

After two month's carpentry work on a six-by-six radio shack that could have been built in this country in a week, the palace into which I was to move the radio set was completed. Before the set was installed, the captain had a trap door cut in the floor which opened into the centre of the library below.

“You never can tell when you may need it,” he explained. “These ‘spigs’ are not much afraid of the American flag that flies from our stern.”



“I EXPECTED GUN PLAY, BUT THERE SEEMED TO BE NO GUNS”

The trap door took another two days, two of the sailors doing the job. It was made with springs and a spring lock. We had a bully time throwing the latch and dropping through to the deck below, for practice.

Finally I transferred the radio outfit and spent the better part of three days getting it tuned up. Then as the oil tankers would arrive or depart I would carry on tests with them and got the outfit working in fine style. By making certain changes in the antenna, it was possible to improve both the receiving and transmitting range. I could count on the old type E tuner and carborundum detector to pull in press from Arlington nearly every night. That meant late working and there were many nights, especially when it was very warm, that I'd fall into the bunk they had built in the room, read a few chapters of some book, and go to sleep.

On one such night I was almost asleep when a commotion on deck startled me. There was a shuffling of feet and I was about to go out and see what it was all about, when the mess boy yelled: "Sparks! Sparks! For God's sake, beat it! Two 'spigs'—" I waited for no more, but dropped through the trap door, slamming it shut as I went through. Then I raced along the lower deck and down to the engine room. As I went, I pulled off my outside shirt and smeared my face with grease grabbed from some of the running gear. The chief engineer happened to be in the engine room and I told him what the trouble was. "Here," he said, as he passed a pair of begrimed overalls to me, "jump into these and be an engineer for a while. I'll go and help Andy get rid of the 'spigs'." (Andy was the mess-boy). As he raced up on deck, I thought of a post card received from my dad a few days before, bearing the cheering message, "Don't Worry." I struggled into the overalls, smeared myself with more grease and went up to the scene of the melée.

By the time I got there the Mexicans were outnumbered and were jabbering in three parts Mexican and one English about wanting only to kill the "telegraphista" who they said was giving information of their activities to overcome the existing ruler of the land. When I appeared they paid no more attention to me than any of the others. Eventually they were calmed down, assured that we bore them no



"I DROPPED THROUGH THE TRAP DOOR"

malice and were lowered into their boat. Then they drifted away with the tide and were soon nothing but a dark spot on the silver-crested Panuco.

Perhaps the firemen and sailors were treated to an even greater surprise than I, for the first mate, a huge down-easter who could not talk without swearing and boasting of his acts of prowess in the good old sailing-ship days, was awakened by the row on deck. As he rushed past the galley to gather his clan from the fo'c's'le the night watchman yelled something about being attacked by Mexicans. As the mate reached the fo'c's'le companionway, he saw a movement in the trees along the shore, became frightened, made for the saluting cannon and shot it off.

The cannon was on the deck just above the crew's sleeping quarters and some of them rushed up in time to prevent the mate shooting away any more of the forward canopy and rail in an attempt to scare off shadows caused by the moonlight among the trees. A very pleasant time was had by all.

# Choosing Your Regenerative Circuit

The Advantages and Disadvantages of the Single Circuit and Three-Circuit Regenerative Receivers

By PAUL F. GODLEY

For some time, RADIO BROADCAST has told its readers of the shortcomings of the popular single-circuit regenerative receiver. In doing so, it has not lost sight of the advantages of such outfits. The belief exists very strongly in many quarters, and there seems to be a great deal of logic behind it, that the benefits of this type of receiver are outweighed by its disadvantages. Many arguments for and against it have been advanced and one dissertation in particular, under the name of a man who should know better, is full of misleading statements, based upon a theory he would like to have the public believe.

Paul F. Godley, the author of this article, is vouched for by all who know him. His remarks concerning the two types of regenerative receivers are clearly put and to the point. If the exponents of the single-circuit receiver can produce as sound a case, we should like to publish it.—THE EDITOR.

WHAT type of regenerative receiver shall I build or buy?" is a question which is asked again and again. It seems that many of those who have had experience are unable to answer this question satisfactorily even for themselves. The intent of this discussion may best be expressed by the belief that an understanding of the simple action of a regenerative receiver will enable any one to clear up the question for himself.

In general, there are two classes of regenerative receivers, and their exponents claim certain advantages for each. They

are known as: single-circuit regenerative receivers (Fig. 1), and three-circuit regenerative receivers (Fig. 2). Both have marked advantages over many other methods of reception.

Because of its simplicity, the larger manufacturers have chosen the single-circuit receiver for their sales campaigns. By utilizing this simplest type, the greatest number of people may be brought to the use of radio in the shortest time. It is interesting to note in this connection that in England, due to a quite general use of the single-circuit type, laws designed to prevent the use of *all* types of regenerative receivers, have been enacted.

In the opinion of the writer, the British law is as far fetched as, perhaps, ours is lax.

The three-circuit regenerative receiver is manufactured at the present time by several of the smaller companies who have consistently clung to this type because of its marked selectivity and sensitivity, in the belief that the gradual education of the public to what is best will eventually lead to a preponderance in number of the three-circuit receiver.

The essential difference between the two types

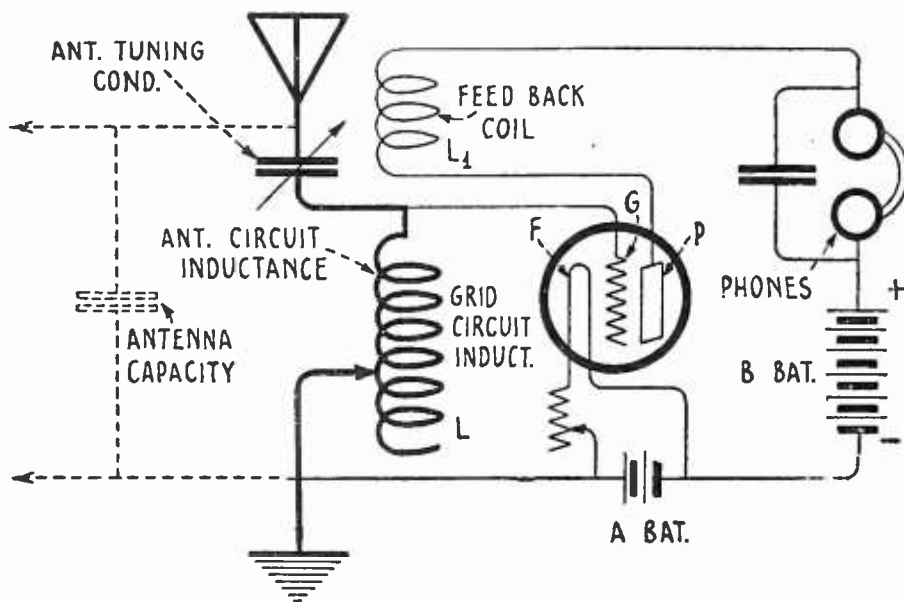

FIG. 1

A typical single-circuit arrangement, with the tube connected directly to the antenna circuit

may be gathered by comparison of Figs. 1 and 2. It will be noted that in the circuit of Fig. 1, the vacuum tube is coupled directly to the antenna circuit, while in Fig. 2, the vacuum-tube circuits are coupled to the antenna circuit through interlinkage of the magnetic fields of the two coils, L and L<sup>1</sup>. In the single-circuit receiver the coupling between the vacuum-tube circuits and the antenna is 100%, in the three-circuit receiver that value of coupling which works out to greatest advantage, both with regard to sensitivity and selectivity, is usually of the order of 1%.

Notwithstanding the size of the United States, considerable annoyance is caused by the energy radiated from regenerative receivers. They actually may be so adjusted as to operate as transmitters. And while all types of regenerative receivers may give rise to interfering energy radiation (unless direct steps have been taken to prevent this) the use of regenerative receivers in which the vacuum-tube circuits are very loosely coupled to the antenna would go so far toward the abatement of this annoyance that the question would never in seriousness be raised as to whether or not we, in this country, should legislate against these "transmitting receivers."

WHY AN OSCILLATING RECEIVER TRANSMITS

**B**UT," you ask, "how does this transmission by a receiver come about?" Also, "If a smaller amount of energy is transferred from the generating circuits to the antenna, would not the same smaller amount of energy be transferred from the antenna to the generating circuits in the case of an incoming signal?" In the answer to these questions lies an understanding of the regenerative principle. Those who would choose intelligently between receivers of various types would do well to study this simple action.

The telephone has been with us now for so many years that it has become a household

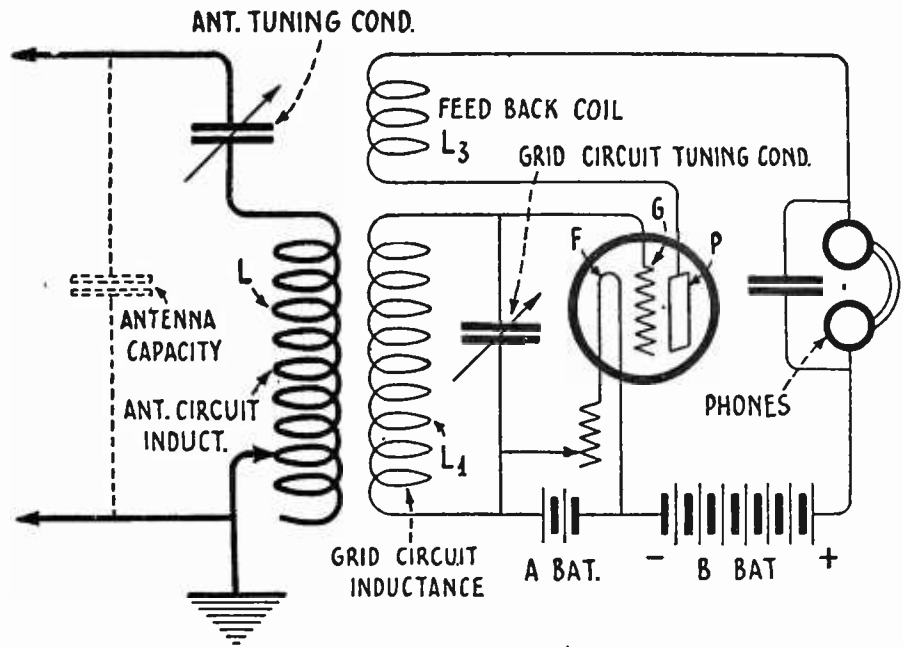

FIG. 2

The three-circuit arrangement. The principal point of difference between this and the hook-up shown in Fig. 1 is that the vacuum-tube circuits are inductively, not conductively, coupled to the antenna circuit

commonplace. Scarcely is there a person who has not endeavored to play the practical joke which may be perpetrated by placing the telephone receiver against the telephone mouthpiece. When this is done, a loud squawking or squealing results, to the great discomfiture of the "party" on the other end. The "squawking" arises due to regeneration—to a "feed-back" of energy as follows: when the receiver, Fig. 3, is placed against the mouthpiece, the slight jarring of the mouthpiece disturbs the carbon granules of the microphone behind it; disturbance of the granules changes the resistance of the microphone, which results in a change of the flow of current through it; the changed current brings about a change of the magnetic lines of force which permeate the induction coil; the sudden rise and fall of the magnetic lines of force create within the *secondary* winding of the induction coil, a fluctuating current which energizes both the telephone line wire and the telephone receiver. If this cycle of changes took place but once, there would be heard in the telephone receiver one very short click. But, so long as the receiver is held to the microphone, the cycle of changes occurs over and over again. The click in the receiver serves to disturb the granules in the microphone a second time, and so on and on. The rate at which these disturbances occur

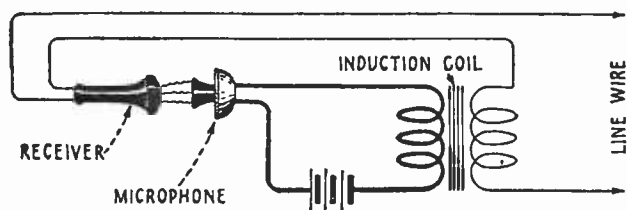

FIG. 3

Illustrating the principle of "feed-back" or regeneration

depends upon the electrical length of the circuit over which the pulsations travel, and the distance at which the receiver is held from the microphone. This rate is usually of such order as to result in a very shrill, screeching noise.

Regeneration in the vacuum-tube circuits is very similar indeed to that outlined above. The grid of the vacuum tube may be likened to the telephone receiver; the electron-filled vacuum between the filament and the plate, to the carbon-granule microphone. Current pulses received by the circuit to which the grid is attached are passed to the grid where they effect a very large change in the flow of the electrons between the filament and the plate. As the charges received by the grid alternate in polarity from positive to negative, the flow of electrons between filament to the plate alternates in magnitude. The current fluctuations in the output circuit are fed back to the grid (input) circuit of the tube. Thus, the grid is charged a second time and a second fluctuation of current in the output circuit results. The magnitude of the current pulse in the output circuit is always greater than that of the pulse which gave rise to it, for the reason that the three-element vacuum tube is an amplifier. Thus the feeding back of the enlarged impulses to the input circuit will result in a still larger fluctuation in the output circuit during the second cycle, and this enlarging action will continue until the resistive forces in the circuit are completely offset.

#### THE HOW AND WHY OF REGENERATION

LET us apply this action in the circuits of Fig. 1. The condenser formed by the antenna and earth, the inductance and the variable condenser across which the antenna (condenser) is shunted, the connecting leads, the by-pass condenser and variometer, or "tickler," in the output circuit of the vacuum tube, all possess inherent qualities which tend

to resist the flow of any kind of electrical oscillation within or through them. If a bit of energy in the form of an electrical current is created in the antenna system, it rapidly spends itself in overcoming this resistive force and, by the time it has reached the point where we expect it to perform its useful function, serious inroads have been made upon it. The extent to which it is dissipated depends, of course, upon the amount of resistance which it is called upon to overcome. But let us assume that the circuit of our diagram (Fig. 1) is average in every respect, and that the resistance encountered is not too great to defeat effective operation. We have insured proper connections in our circuit and lighted the filament of the vacuum tube. Immediately this is done, current supplied by the B battery starts an electron flow across the vacuum from the filament to the plate.

By controlling the electrical length of the output circuit (varying the inductance and capacity in it) let us "time" or tune the journeys of the current pulses in it and transfer a portion of the output circuit energy, *at the proper time*, back into the grid or input circuit. If the timing (tuning) has been properly done, the charge upon the grid will be reinforced by that heavier charge taken out of the plate circuit.

In the ordinary regenerative vacuum-tube receiver, the electron discharge of the tube and the power stored up in the batteries may be called upon to an extent sufficient to generate oscillatory energy at a very rapid rate. An antenna of two or three hundred ohms—and this is quite a high resistance—will not serve to prevent this vacuum tube action from compensating for the resistance of the circuits. It is for this reason that the regenerative circuit has proven so effective as a radio receiver. Theoretically, no matter how inefficient may be the units which comprise the circuit, the vacuum tube, by regeneration, makes up for inefficiencies, but practically efficient units are of as great advantage in the regenerative receiver as in any other type, for, it will be remembered, the vacuum tube does not compensate for circuit inefficiencies when it is not carefully adjusted to a point just below oscillation or when it is not actually oscillating. The value of efficient units, therefore, is apparent in the preliminary adjustments necessary when tuning in a station, when it is impossible to hold all circuits at this critical



point. The currents upon the grid are those which control the action outlined. The character of the oscillatory currents in the whole circuit are determined by the form or character of those which reach the grid from the antenna. The circuit which we have been treating above is that of the single-circuit receiver. When the currents in the grid circuit of this receiver have been reënforced by the feed-back of energy, the currents in the antenna circuit have also been reënforced, for grid and antenna circuits are so closely coupled by the inductance and capacity common to both of them, that they act as one.

#### WHERE THE THREE-CIRCUIT RECEIVER DIFFERS

**I**N THE three-circuit receiver of Fig. 2, this is not true. For example, let us assume that the vacuum-tube circuits are quiescent, and that a signal pulse arriving upon the antenna induces a like signal current in the secondary circuit of Fig. 2. The charge arriving upon the grid as the result of this inductive action will be slightly smaller than that charge arriving upon the grid had the grid circuit and antenna circuit been very closely coupled, depending upon the excellence of design of the receiver circuits. But, this slight loss, along with other losses of the circuits, may be, and is, fully compensated for by regenerative action and the signal built up and up in the system until its value is equal to or greater than that of the energy placed in the antenna by the passing electric wave. As the regenerative energies in the grid circuit grow larger and larger, their tendency toward control of their own destiny becomes greater and greater. Conversely, their dependence upon the form or nature of those oscillations in the antenna circuit be-



#### KEEPING IN PRACTICE

Paul Godley taking copy from the New Brunswick, N. J. transatlantic station at 50 words a minute

comes less and less, and this divergence may increase until they are, in effect, unguided by the form of the oscillations in the antenna circuit. Therefore, if coupling is too loose, distortion will set in. When it is too tight, it is impossible to secure the maximum benefits of regenerative amplification. Between the two lies the ideal—some arrangement which provides control over the coupling between the antenna and grid circuits and which makes it possible for us to reach this ideal.

In the case of the three-circuit receiver, the regenerating circuits are working upon a *slightly* weaker initial signal and when too loosely coupled are prone to distortion, resulting from lack of guidance. In the single-circuit receiver the guiding forces are 100% present and there are, in addition, many other stray forces—forces existing in the antenna due to shocks which it receives from powerful

"off-wavelength" oscillations which pass through it. These forces may have been caused by powerful amateur or ship or naval stations, by discharges of faulty electric lines, telephone circuits, "buzzer" circuits, and what not. From the foregoing it may be understood why the single-circuit receiver is subject to these disturbances and it may also be understood why the three-circuit receiver, comparatively, is free from them.

Where the regenerative circuits are to a large degree freed from external influence, they may be *very gradually* adjusted toward those settings where maximum regeneration without oscillation (and therefore maximum undistorted signal) is had. Let us suppose this freedom is lacking. When the adjustments are approaching a very critical setting, if some disturbing external influence suddenly throws into the circuit a powerful pulse, the pulse is repeated through to the output circuit and in its greatly enlarged form, back into the grid circuit. Thus the circuits are suddenly thrown into oscillation and the signal distorted. Where the antenna circuit is directly coupled to the grid circuit, this effect is continually taking place. It makes it impossible to secure a maximum of undistorted regeneration, so that, whereas in the case of the direct-coupled circuit the *initial* signal is slightly larger, it never can be so greatly enlarged due to regenerative action as in the coupled circuits.

Although the key to the ideal case for the regenerative receiver lies in the control of the coupling between antenna and vacuum-tube circuits, the idea must not be had that a continual adjustment and read-

justment of this coupling value is necessary. In a well designed receiver it is not. For a given band of wavelengths, say, 360 to 400, and a given antenna, the value of this coupling may be chosen and allowed to rest. This value varies greatly for different antennas, depending upon their resistance, and it may vary slightly for fairly large changes in wavelength, for the resistance of any circuit will change with wavelength.

The observing reader will have foreseen the result of the coupled-circuit receiver with regard to what is known as selectivity—freedom from undesired signals. And, too, he will have noted that in so far as manipulation of the circuits within a given band of wavelengths is concerned, he has three variable controls to deal with instead of two. In the single-circuit receiver there is the wavelength dial—the dial which governs the wavelength of the antenna-grid circuit and the regenerative control. In the three-circuit receiver there are the wavelength dials of the grid circuit and the dial which serves to keep the antenna circuit in resonance with the grid circuit, and the regenerative control. To be sure, there is no technique required to operate the one, while a certain amount of technique *is* required to operate the other; but who does not take pride in the mastery of a thing, and who is there that enjoys the radio concert or the conversation with a friend half a continent away, who would not give a few hours of application to technique in order that his pleasure may be increased by freedom from disturbance, and by the knowledge that he is causing a minimum of interference to others?

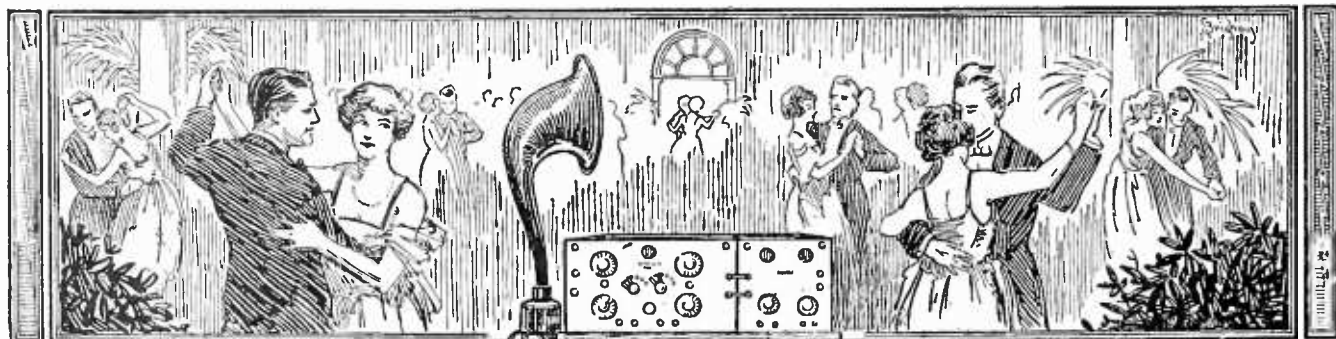

# International Law and the Sea-Going Telegrapher

By CLAUDE CATHCART LEVIN

Associate Editor of *The American Officer*

**U**NDER the provisions of The London International Radio-telegraphic Convention of 1912, the nations signatory thereto bind themselves to take or propose to their respective legislatures the necessary measures for insuring the carrying out of the Convention's regulations.

Thus the radio laws and regulations of the U. S. are fundamentally those of the London Convention, as are also those of the other signatories.

Great Britain, however, realizing the inadequacy of laws framed in 1912 as applied to modern communication, has gone much farther and has passed legislation affecting radio which stands as a model and which will undoubtedly have great influence in the next convention whenever it is held.

Under British law, ships are divided into three classifications:

1. Those carrying 200 or more persons and not engaged in British coastwise trade.
2. Ships not engaged in British coastwise trade carrying 50 but less than 200 persons, and ships engaged in British coastwise trade carrying 50 persons or more.
3. Ships carrying less than 50 persons.

The rules in general require that a vessel of the first class shall carry three licensed radio operators; that a vessel of the second class shall carry one certificated operator and two certificated watchers, and that a vessel of the third

class shall carry one certificated operator. The "certificate" corresponds to the "license" issued to radio operators by the American Government.

The provisions of the act apply to all vessels, foreign as well as British, of 1,600 gross tons and over touching at British ports, and are now in force throughout the United Kingdom, Australia, and India.

These provisions are far ahead of those of America and the other nations which have not passed similar legislation and which are operating under their own laws based upon those of the Convention.

Under the provisions of the Convention, ship stations in constant service are required to have on board at least two certificated radio operators, who will maintain constant service

(this on vessels carrying 50 or more persons and traveling certain distances). On ships carrying less than 50 persons, radio is not compulsory.

The application of the British law to vessels of all other nations was quickly felt. Italy soon passed similar legislation, with the result that the situation there is practically the same as in the United Kingdom, except that they have no watchers. (A watcher is a person certified to be able to receive a distress signal at a slow rate of speed and is not required to fulfill the regular duties of an operator.)

Norwegian, Danish, and Scandinavian vessels were particularly affected and were forced to place radio on many ships which had not

## The Radio Man at Sea

The best of laws become obsolete, and we find it hard to reconcile our present activities in radio with the law of 1912. From the point of view of the operator, that law is far from satisfactory, and it is true that although conditions at sea are not entirely despicable—as some of the more radical unionists would have us believe—there is plenty of room for improvement.

The author has been in close touch with the matter and has served as President of the United Radio Telegraphers' Association. He is Associate Editor of *The American Officer*, a marine publication, and is conversant with marine radio affairs. RADIO BROADCAST would like to receive articles on the subjects discussed in this article from other men who are helping to make life safe at sea.

—THE EDITOR.

been equipped before. Recent press dispatches state that the Danish Parliament is considering the passage of legislation similar to the British act in order that their ships may not be handicapped, as foreign vessels visiting Danish ports will then be required to comply with the laws.

French law is rather involved, being designed to conform to the requirements of the naval and military services as well as of the merchant marine.

Especially during the last few years, the world has greatly felt the need of new, unified, international radio legislation to suit present conditions and to provide for the future.

The framers of the London Convention, realizing that the art would grow beyond its stage of development in 1912, provided in part as follows:

The provisions of the present Convention and of the Regulations relating thereto may at any time be modified by the High Contracting Parties by common consent. Conferences of plenipotentiaries having power to modify the Convention and the Regulations shall take place from time to time; each conference shall fix the time and place of the next meeting.

It was agreed that the next Conference should be held at Washington in 1917.

Owing to the war it was decided to postpone the Conference. At the Peace Conference at Paris in 1919, the following agreement was reached with respect to calling an International Electrical Communications Conference:

The Principal Allied and Associated Powers shall, as soon as possible, arrange for the convoking of an international conference to consider all international aspects of communication by land telegraphs, cables and wireless telegraph, and to make recommendations to the Principal Allied and Associated Powers with a view to providing the entire world with adequate facilities of this nature on a fair and equitable basis.

A preliminary conference of representatives of Great Britain, France, Italy, Japan, and the United States was held at Washington, beginning in October, 1920, for the purpose, among other things, of preparing an agenda for the International Electrical Communications Conference. The reports adopted at this Conference have been submitted to the governments of the world for their comments and the United States Government has received many replies.

United States Representatives accredited to

governments which have not as yet furnished an expression of their views concerning these reports have been instructed to endeavor to obtain a statement of the views of these governments.

The replies which have been received are being studied, and careful consideration is being given to the matter of determining when further action shall be taken by this government with respect to the next International Radiotelegraphic Conference.

A short time ago there met in Brussels representatives of professional radio telegraphist associations of Belgium, Denmark, Great Britain, Holland, Greece, Italy, and Sweden, and here was formed The International Federation of Radiotelegraphists.

Realizing the great need of new International Legislation, the Federation adopted the following resolution on behalf of its members, the sea going radiotelegraphists of the world:

1. To secure adequate representation on any international authority dealing with wireless matters affecting the position of marine radiotelegraphists.
2. To secure the uniform and satisfactory application of wireless telegraphy on board ship so as to assure the maximum degree of safety of life at sea.
3. Instructing the Secretary to demand recognition by the International Radiotelegraph Convention, and to ask that at least one representative from the Federation should be present at the next Convention. Fixing the basis for an international manning scale.
4. Calling for the introduction of uniform classes of certificates by the International Radiotelegraph Convention.
5. The collection and dissemination of news and information regarding the state of the profession, etc., in various countries.
6. That the operation of wireless telegraphy at sea in all its branches be performed only by qualified operators.
7. That the English and French languages be learned by operators.

The United States Government has received an invitation from the French Government to participate in the International Electrical Communications Conference which it is proposed to hold at Paris this year. It has not yet been decided, however, whether this government will accept the invitation of the French Government, and an announcement concerning this is expected shortly.



# Soldering Your Own

By W. S. STANDIFORD

**O**F THE many people throughout the United States and Canada who are making and installing their own sending and receiving sets, the majority are comparatively "new to the game" and have trouble in getting soldered joints that will remain firm. *It is of great importance to the working of any radio outfit that a clear path for the electrical energy (which at its best is very weak) should be provided, so that no buzzing sounds due to loose connections are heard along with the signals.*

Soldering wires on variometers and other parts is easy, once the knack of handling a soldering iron is learned. It is better for those who have never done work of this kind to try it first on some spare pieces of copper wires twisted together. Soldering irons, or coppers as they are termed, range in weight from a few ounces to several pounds. They can be either made or bought. The lighter ones are easier to handle, but lose their temperature very quickly compared to the heavier irons. One weighing about three fourths or one pound (shank and handle not included) is about right for most radio work. The soldering iron shown in the accompanying photograph weighs close to one pound, and was made by the writer from a one-inch copper bar, the shank being made from a poker, and the wooden handle obtained from an old broom.

In order to do good work in soldering, five things are essential. The point of a soldering iron has to be coated with solder or "tinned," as it is termed by men who make a living doing this work. The portion to be joined must be made very clean, either by scraping with a piece of a sharp knife blade kept for this purpose, or filed, or rubbed with emery cloth—whichever method proves the handier. The parts that need soldering ought to be heated above the melting point of solder. In ordinary classes of small work, such as soldering one wire to another or sheets of metal to other sheets, the

heat of the soldering iron itself must be sufficient not only to melt the solder, but also to raise the temperature of the metal to be fastened together, so that firm joints are made.

Do not let your iron get too hot, that is, red-hot; or it will not take up any solder at all. Lastly, it is best to keep the iron well tinned at all times, so that when you want to use it, it is always ready, and you will thus save time by not having to re-tin it. New irons sold in hardware stores are in the rough state, with no tinning upon their points. Most of them also have no handle, which has to be bought separately. It is necessary after one is put on, to smooth the four sides of the iron with a medium coarse file so as to make the tin stick to it. To tin these sides, put the iron in a clear, red coal fire, which is not giving off any smoke. Heat it until nearly red-hot. When it has the right degree of heat, the solder will melt instantly when it is applied to the iron. At this stage, if it is held about 3 inches away from the palm of the hand, the heat given off from the hot metal may be felt. This will serve as a guide for future heatings instead of touching solder to the tool.

Have some powdered rosin, together with solder, on a board. Quickly brighten one face of the soldering iron with a file or a piece of sandpaper tacked on a block of wood and then rub it rapidly into the rosin and solder mixture. The surface of the copper bit will be found to have taken a shiny coating of solder. Repeat this process with the other sides until they are tinned. If it should happen that a soldering

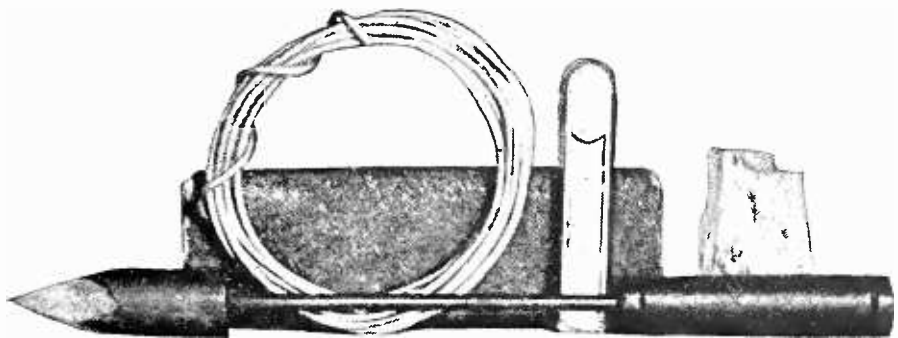

A "TINNED" SOLDERING IRON AND ACCESSORIES

Behind the iron are a coil of wire solder, a bar of "half-and-half" solder (composed of tin and lead), a strip of emery paper tacked on a wooden block, and a lump of sal ammoniac

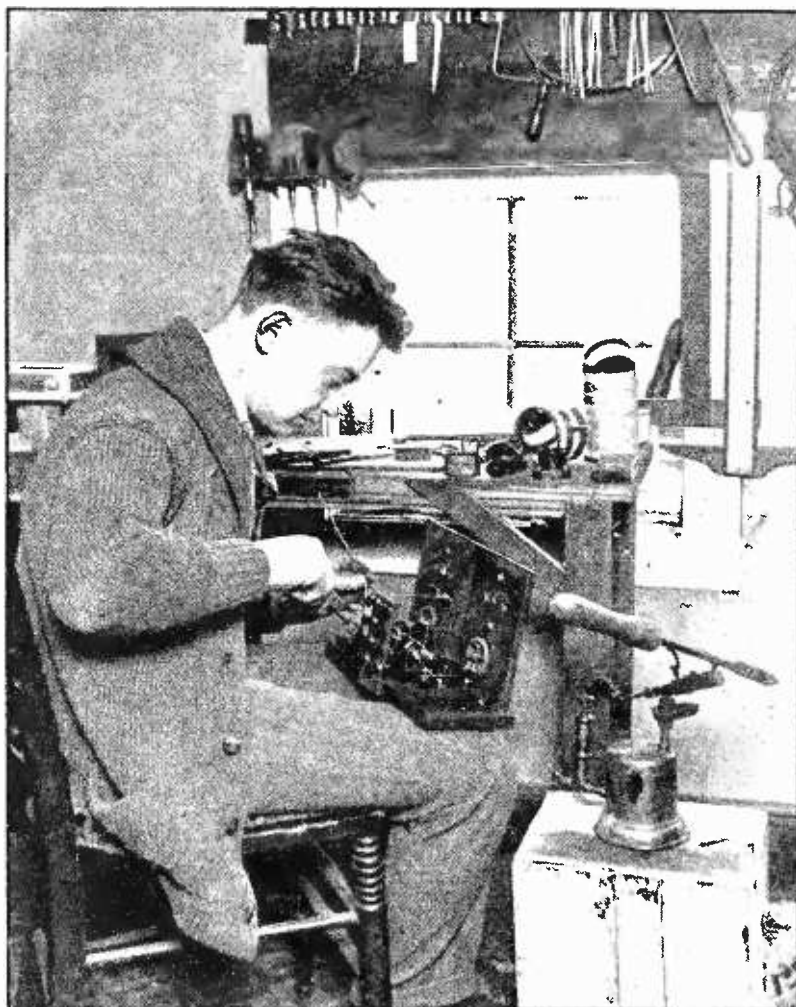

TO SEE YOUR APPARATUS GROW UNDER YOUR HAND  
From a heterogeneous mess of parts into a neat, well-soldered radio receiver, and to connect up that receiver and pull in signals—distant signals—that is truly a “gr-r-rand and glor-r-rious feelin’”

iron refuses to take a tin coat, heat the copper a bit more, but not red-hot; file its face and rub it on a lump of sal-ammoniac to remove any grease, then plunge into the rosin and solder flux. A few trials will enable any novice to do good tinning work.

Once the nose of an iron is “tinned”, it will remain so, provided it has not been overheated so as to burn off the solder or cause it to become alloyed with the copper. This condition can be easily recognized because the surface of the copper turns black. If this occurs, file and re-tin the four sides.

Having coated the tool with tin, you can proceed to use it on the wires of your radio outfit, it being presumed that you will have practiced soldering other pieces of wire before trying this work on your apparatus. A description of fluxes and their action will be touched upon, as fluxes play a most important part in soldering work. The main reason for

using fluxes in order to make joints that will not become loose, is that a thin film of oxide always forms upon all brightened surfaces of metals, this oxide being caused by action of the air. Fluxes dissolve and prevent any further oxide forming and thus allow the solder to stick directly to the metallic body, instead of to an oxide film which, sooner or later, allows the joints to come apart.

To solder twisted wires on variocouplers, untwist the ends, scrape the insulation off the ends, and brighten them with emery or sandpaper. Then coat them with rosin flux, taking care not to get any of it on the insulation. Heat the iron in a gas or coal fire until it has acquired the right temperature, when the solder on its tinned surface will be observed to melt. This shows it to be hot enough. Remove it from the fire, give it a quick rub on a piece of old carpet or heavy rag and touch it to a bar of solder. A drop of the latter will adhere to the iron and can be conveyed to the wires that need uniting. Hold the hot copper on the junction. As soon as the wires are hot enough, the solder will leave the iron and flow over them. Re-

move the iron, but do not disturb the joint until the solder has set. This will be shown by a sudden dulling of its surface. It may be necessary to add more solder to the joint. In this case, add more flux and put on another drop of metal.

Some radio fans use aluminum wires for aeriels and try to solder the joints with ordinary “half-and-half” tinner’s solder and then wonder why it does not stick to the wires.

Aluminum has an oxide on its surface which reforms as quickly as it is removed. For this reason a special solder is needed. If possible, a radio enthusiast who desires to use an aluminum wire aerial should have a wire long enough to reach the binding posts of his set without any soldered connections in it. Should this be impracticable, then resort will have to be made to a soldered lead-in wire. If this work is done with a solder and flux of the formula given, aluminum wires may be united with

little trouble. The formula for aluminum solder is 79 per cent. tin, 20 per cent. zinc, and 1 per cent. aluminum. Obtain a dry, grooved board with a slot cut in it the thickness of a lead pencil. Stop up both ends and pour the hot metal from the iron ladle into it. The flux is composed of equal parts of stearic acid and rosin, melted together and well stirred. A bar of common yellow laundry soap melted up with a sufficient amount of rosin so as to make a mixture that can be spread on with a stick, will also make a good flux.

Heat the place on the wire with a blow torch until it is hot enough to melt the solder (which differs in the ordinary variety in that it flows more sluggishly), then quickly rub the hot surface with flux and tin it well with the solder,

pushing the latter backward and forward. This removes the oxide and prevents any more from forming. When both wires are thoroughly "tinned," wind one over the other in the usual manner. Heat the joint again and apply more flux and solder so as to cover both parts well. In aluminum soldering, it is better to have each wire covered with a plentiful supply of solder so as to exclude moisture. This solder will impart a strength to a joint nearly equal to the strength of the metal itself. An aluminum soldering "iron" will be found to work better than a copper one, although the latter can be used successfully for aluminum work. Joints on outside aerials should be painted with several coats of spar varnish, to keep out the moisture.

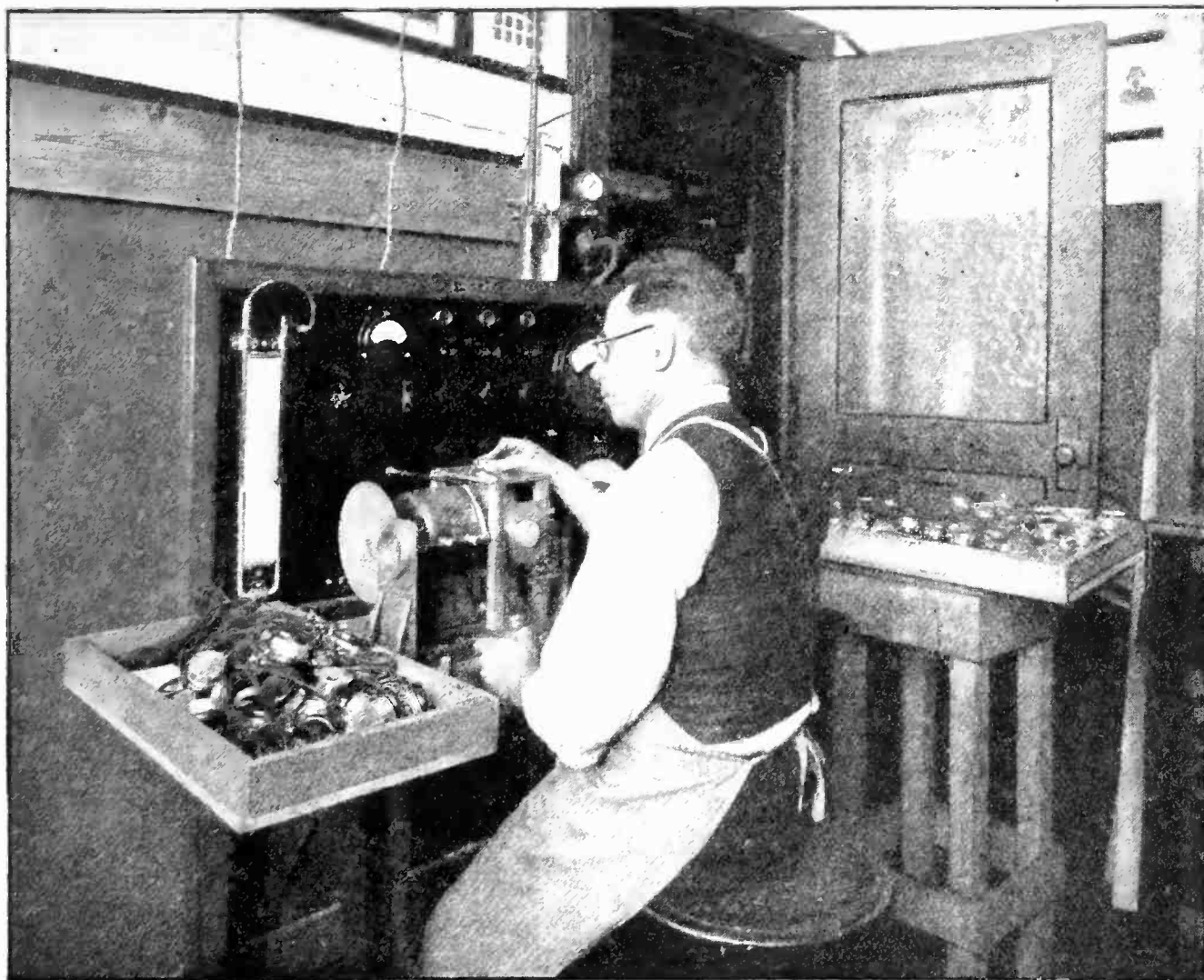

TESTING TELEPHONE RECEIVERS

In the factory of the Holtzer-Cabot Company. The operator is able to determine the tone quality, distortion, and volume of the receivers, directly from the meters, as readily as one can determine resistance by the use of a Wheatstone Bridge

# Broadcast Receiving Contest!

## Any Number of Tubes—Any Kind of Receiver

THE LONG-DISTANCE RECEIVING CONTEST, to determine who has done the best with ANY NUMBER OF TUBES AND ANY TYPE OF RECEIVER, is in full swing. The drawbridge will be hauled up at sunset on MAY 31st, however, and after that even the most imposing-looking contributions will have to be left outside the portcullis. A great many of them will probably gallop through in a cloud of dust at the last minute—but that is dangerous business, and we advise you not to try it. Read through the Eight Commandments below, roll up your sleeves, and go to it.

### The Four Prizes

#### First Prize: DE FOREST D-7 REFLEX LOOP RECEIVER

This receiver, described in RADIO BROADCAST for February (page 207), is the latest product of the De Forest Company: it makes three amplifying tubes and a crystal detector do the work of six tubes. The loop antenna aids in selectivity because of its directional properties. An ordinary antenna and ground may be used, however, if desired. Recently, a man in Brooklyn, N. Y. heard a broadcasting station in Seattle, Wash., with one of these sets.

#### Second Prize: GREBE TUNED RADIO-FREQUENCY AMPLIFIER, TYPE "RORN"

This amplifier, which has a wavelength range of from 150 to 3000 meters, may be used with any form of home-made or bought receiver. It is the most recent development of a company widely known for the excellence in design and workmanship of its products.

#### Third Prize: Choice of

THREE OF THE NEW RADIOTRON UV-201-A AMPLIFIER TUBES (6 volts,  $\frac{1}{4}$  of an ampere), or

THREE AERIOTRON WD-11 DRY CELL TUBES ( $1\frac{1}{2}$  volts,  $\frac{1}{4}$  of an ampere).

#### Fourth Prize: TIMMONS LOUD-SPEAKER UNIT

This unit, which may be connected directly to the output of your amplifier, has a diaphragm adjustable for sounds of different intensities, and when used with two stages of amplification reproduces broadcast programs about as loud as the music from the average phonograph.

### Rules of the Contest

1. You should list all broadcasting stations 150 or more miles away from the receiving point, which you have heard distinctly (announcement of location as well as of call letters.)
2. Measure distances accurately, and give aggregate mileage. (This is the sum of all the distances, each station counted once, but two or more stations in the same city being counted separately.) An aggregate mileage of less than 15,000 miles will not be considered.
3. Manuscripts should include the following: description of set, directions or advice for constructing and operating it; any "wrinkles" or makeshifts which you have used to advantage; photograph of your apparatus; circuit diagram; in general, anything you have to tell that will make your story more interesting and helpful. Manuscripts should not be longer than 2000 words. Typewritten ones preferred.
4. Data should be arranged in three columns, under the headings: call letters, location, distance.
5. For material used, a liberal rate will be paid.
6. In judging contributions, the quality and interest of photographs, text, and drawings, and the originality and general effectiveness of the apparatus described, will have greater weight than the list of stations heard, although a long list of distant stations will distinctly help.
7. The Contest closes May 31st, 1923.
8. Address: Receiving Contest, RADIO BROADCAST, Doubleday, Page & Co., Garden City, N. Y.





## A Bit About Books



ONE of the best books designed to assist the broadcast listener and the amateur to know who is on the air is "The Citizens' Radio Call Book." It contains the call letters of American and Canadian Broadcasting and Amateur Stations; Experimental and College Stations; Naval Radio Stations; press schedules of radio stations throughout the world and a list of high-power trans-ocean stations. It is arranged in a very convenient manner and is well worth its price: fifty cents.

Citizens Radio Service Bureau, 416 So. Dearborn St., Chicago, Ill.

In a thirty-two page booklet called "Getting Acquainted with Radio Receivers," Paul Godley has told a great deal about the use of receivers for broadcast reception. Mr. Godley's work is truly a short course in radio-electricity. Much of the book is devoted to the installation and operation of "Paragon" receivers, but there is a wealth of information which will be found valuable by the operator of any type of regenerative receiver. The book may be had for twenty-five cents.

Adams-Morgan Company, Upper Montclair, New Jersey.

"Radio Reception" by Harry J. Marx and J. Adrian Van Muffling, is a real radio book and is full of practical information for the fellow who builds his own. It is simple and complete and well illustrated. The book contains 92 illustrations and 38 diagrams, and includes a brief outline of applied radio-frequency amplification.

G. P. Putnam's Sons, New York City.  
Price \$2.00.

A rather complete book on radio from the early days to the present, from crystal receivers and double-slide tuners to super-regeneration and the transmission of photographs by radio is Dr. Henry Smith Williams' "Practical Radio." There are a great many illustrations which serve their purpose admirably. The functions of various radio devices are clearly and correctly portrayed and described in a helpful and interesting manner. Here, indeed, is a volume of worth for the beginner and the more advanced enthusiast. It is just what its name implies—Practical Radio.

Funk & Wagnalls Company, New York City.  
Price \$1.75 (\$1.87 postpaid).

"Letters of a Radio Engineer to His Son" is a book designed for those who would understand the reason for various actions that take place in a vacuum tube whether it be employed for receiving or transmitting. John Mills, the author, has told this story in a very complete and comprehensive manner, but these letters would hardly interest the average son unless he is well along in high school. If the book you seek is one on "how to make it," this is not the book for you, for, although it explains design in a complete manner, no attempt is made at assembly and panel layout. There are more helpful books for those who build their receivers and transmitters from standard parts, but for the person who takes pleasure in designing his own units this work is of great value.

Harcourt, Brace & Company, New York.  
Price \$2.00.

# All Boy Scouts, Attention!

*RADIO BROADCAST announces a contest, starting now and ending July 31, 1923, to determine WHAT BOY SCOUT TROOP HAS DONE OR IS DOING THE MOST WITH RADIO.*

## Prizes for Winning Articles

**FIRST PRIZE: CROSLY MODEL X 4-TUBE RECEIVER.**

*This receiver, which may be used with dry-cell tubes if desired, consists of detector, one stage of tuned radio-frequency and two stages of audio-frequency amplification. (Advertised in RADIO BROADCAST).*

**SECOND PRIZE: MUSIC MASTER LOUD SPEAKER.**

*This is the new loud speaker made by the General Radio Corporation. (A picture and description of it appear in the advertising pages of RADIO BROADCAST).*

**THIRD PRIZE: THREE**

*The WD-11 is the well-known dry-Corporation. (Filament voltage 1.5,*

*A YEAR'S SUBSCRIPTION TO given as prizes for the ten next best*

*These prizes will be awarded to troop may delegate one of its members to*



**WD-11 VACUUM TUBES.**

*cell tube manufactured for the Radio plate voltage 22½—45).*

*"RADIO BROADCAST" will be contributions in this contest.*

*troops, not to individuals, although any prepare the story.*

## Rules of the Contest

1. *Articles must be true accounts of radio with relation to your particular troop: what you have done, or are doing, or both.*
2. *Every article must be written by a Scout or by more than one Scout belonging to one troop.*
3. *Articles should be between 500 and 1000 words long.*
4. *Good photographs to illustrate the article will count 50% in judging contributions.*
5. *Typewritten manuscript, double-spaced, is desired, though not required.*
6. *Address contributions to Scout Contest, Radio Broadcast, Doubleday, Page & Company, Garden City, N. Y.*

*Scouts have done splendid work in maintaining communication by radio in time of floods and disaster, in copying and spreading the market reports transmitted by the government Farm Bureaus, in training themselves along mechanical and electrical lines, and, in short, in using radio as a part of scout work in a way consistent with the best traditions of scouting. What have you to tell of your troop's past or present activities? Get your scribes and photographers under way with that story which will put in a strong bid for first prize. How would a receiver with three stages of amplification go in your troop?*

*Beginning with the July number of RADIO BROADCAST, the best articles will be published. The winners will be announced in the September number, and unless the three best articles have been previously published, they will appear in that issue.*

## Next Month—More About the Grimes Circuit

The article by Mr. Charles H. Durkee in our April number, "1300 Miles on a One-Foot Loop," resulted in a deluge of correspondence from interested readers. The article described the "Inverse Duplex" receiver developed by Mr. David Grimes, of Staten Island, N. Y.

RADIO BROADCAST has arranged to have Mr. Grimes explain to you, next month, how you can construct this receiver and how it should be adapted for use with various types of tubes now on the market. It is the ideal vacation outfit.—THE EDITOR.

# New Wavelengths for Class B Stations

Revised Schedule, Issued by Department of Commerce, in Effect on May 15th

**T**O CLEAR up the congestion in radio broadcasting, says the *New York Times*, a new schedule of wavelengths, going into effect on May 15, has issued from the Department of Commerce, which has been working on the problem ever since the recent National Radio Conference.

Definite wavelengths have been allocated to each of five zones into which the country has been divided, and broadcasting stations will have to adhere to these or suffer the penalty of loss or suspension of license.

For the Class B stations (the high-power transmitting agencies) there will be ten wavelengths in each zone, and each of these will be adjusted so as not to conflict with any other.

Of the ten zone lengths assigned to Zone 1, which extends from New England through the District of Columbia, three of them, 405, 455, and 492 meters, have been assigned to New York City and Newark. This is because so many persons are served by the stations in the neighborhood, and so much entertainment talent is available. The stations in New York and Newark will have to arrange for division of time.

Other assignments of wavelengths thus far in this zone are:

Springfield, Mass. (Westinghouse station) and Wellesley Hills, Mass., 337 meters.

Schenectady (General Electric), and Troy (Rensselaer Polytechnic), 380 meters; Philadelphia (Wanamaker's, Lit's, Strawbridge & Clothier), 509 and 395 meters, and Washington (Arlington and Radio Corporation), 435 meters. It is likely that Arlington will have a special wavelength and not be forced to divide time with any other station. Wavelengths of 303, 319, 469 meters also are reserved for this zone.

Assignments in the other zones up to this time are:

Zone 2—Pittsburgh, 326; Chicago, 448;

Davenport and Des Moines, 484; Detroit and Dearborn, 517; Cleveland and Toledo, 390; Cincinnati, 309; Madison and Minneapolis, 417.

Zone 3—Atlanta, 429; Louisville, 400; Memphis, 500; St. Louis, 546.

Zone 4—Lincoln, Neb., 341; Kansas City, 411; Jefferson City, 441; Dallas and Fort Worth, 476; San Antonio, 385; Denver, 323; Omaha, 527.

Zone 5—Seattle, 492; Portland, 455; Salt Lake City, 312; San Francisco, 509 and 423; Los Angeles, 395 and 469; San Diego, 536.

## NOTHING ABOVE 600

None of the wavelengths goes above 600 meters. This is important to amateurs, as according to a plan proposed to the recent conference the large stations might have had wavelengths up to 700 meters, which would have necessitated the changing over of many receiving sets.

Besides the Class B stations, which broadcast to long distances, there are 540 Class A stations which use the 360-meter wavelength. These will be allowed to retain that wavelength or can come into a special band between 222 and 300 meters. If a new station is erected and it cannot meet the qualifications of a Class B station it will not be allowed to use 360 meters, but must go into the 222-300 band.

Because of the great activity in radio, the Department of Commerce is enlarging its forces in the inspection districts of which there are nine with Boston, New York, Baltimore, Atlanta, New Orleans, San Francisco, Seattle, Detroit, and Chicago as headquarters.

Beginning May 15, inspectors will check the wavelengths of stations in their districts.

It was stated that any station now operating on 360 meters has the privilege of remaining on that wavelength. It is also emphasized that the assignments of wavelengths are for cities and not for specific stations.

# The Grid

## QUESTIONS AND ANSWERS

The Grid is a Question and Answer Department maintained especially for the radio amateurs. Full answers will be given wherever possible. In answering questions, those of a like nature will be grouped together and answered by one article. Every effort will be made to keep the answers simple and direct, yet fully self-explanatory. Questions should be addressed to Editor, "The Grid," RADIO BROADCAST, Garden City, N. Y. The letter containing the questions should have the full name and address of the writer and also his station call letter, if he has one. Names, however, will not be published.

### LOOPS

*The writer would appreciate publication, in an early issue of RADIO BROADCAST, of information concerning the construction of a loop antenna.*

H. H. S., Pittsburg, Pa.

**I**N WRITING to *The Grid* for constructional data, correspondents are requested to furnish the editor with all possible information concerning the use to which the apparatus is to be put. This should include, when pertinent, frequency (supply line), wavelength, voltage, current, sizes, the experience of the correspondent and a description of available material. This will greatly add to the facility with which our advice may be carried out, and to the general usefulness of this department.]

It is assumed that our inquirer desires to construct a loop for broadcast reception. The most desirable size for such a purpose is a compromise between the more efficient larger sizes and the convenience and mobility of a small frame—a square loop, three feet on a side, the various dimensions of which are indicated on the working drawing of Figure 1.

The loop is of the solenoid type, i. e., wound in "box"

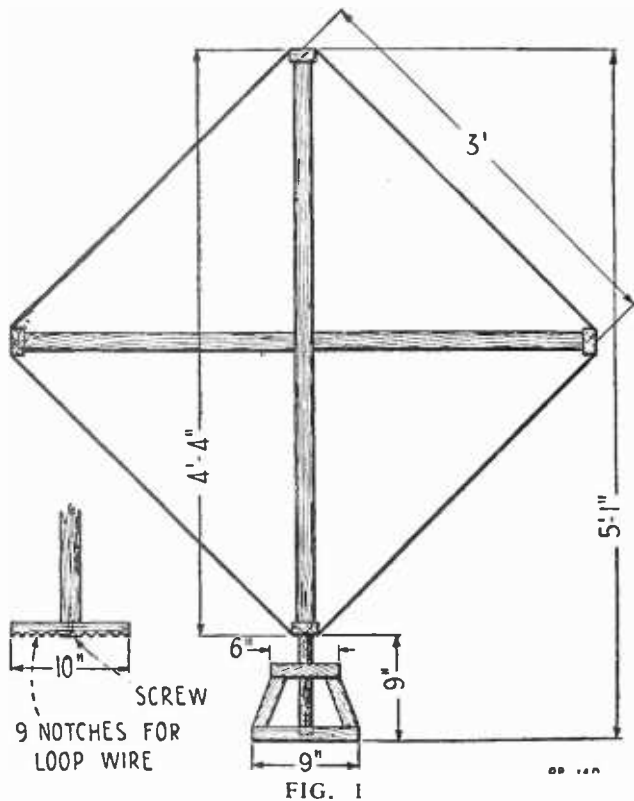

Showing dimensions for a loop for broadcast reception

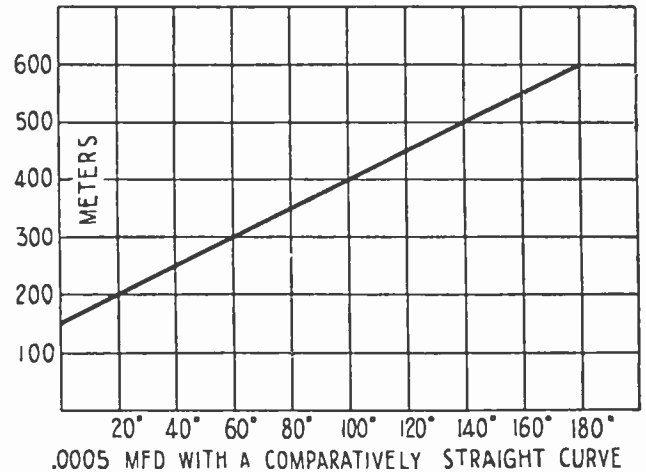

FIG. 2

form rather than as a spiral. There are nine turns of wire, separated one-half inch, wound in grooves sawed in the end pieces. Any convenient wire may be used. Green double silk covered, number eighteen, is perhaps the most easily manipulated, and when wound on a stained frame, the finished loop presents a very creditable appearance.

The frame is constructed of one by one-and-a-half inch lumber. The upright may be drilled at the lower support on which the wires are strung to pass the middle wire. The other wires of course pass on either side of the upright. The construction of the base is clearly shown, the holes through the top and into the bottom being one inch in diameter, and the lower eight inches of the upright rounded to fit with sufficient looseness to permit turning.

Figure 2 shows the approximate wavelength range of this loop when shunted by the average .0005 mfd. plate condenser.

The indoor loop, as described, will give satisfactory results only when used with radio-frequency amplification. Employing two stages of transformer-coupled, or one stage tuned plate R. F. amplification, detector and two steps of audio-frequency amplification, stations one thousand miles distant should be received with very good audibility.

### A. C. FOR RECEIVING FILAMENTS

*Is there any possible way in which I can light the filament of my detector bulb from 110 volts alternating current? I thought, perhaps, the A. C. could be stepped down to six volts by a transformer, and this changed to direct current through a rectifier. Choke coils would be used to smooth out*